



CERTIFICATE OF APPROVAL

No CF 5060

This is to certify that, in accordance with
TS00 General Requirements for Certification of Fire Protection Products
The undermentioned products of

ASSA ABLOY LIMITED T/A LORIENT

Portobello Works, School Street, Willenhall, WV13 3PW, United
Kingdom

Tel: 01626 834252 Fax: 01626 833166

Have been assessed against the requirements of the Technical Schedule(s)
denoted below and are approved for use subject to the conditions
appended hereto:

CERTIFIED PRODUCT

Lorient System-36 PLUS
Glazing Gaskets

TECHNICAL SCHEDULE

TS25 Fire Resistant Glass,
Glazing Systems and Materials

Signed and sealed for and on behalf of Warringtonfire Testing and Certification Limited

Paul Duggan
Certification Manager



Issued: 4th July 2012
Revised: 1st March 2023
Valid to: 29th January 2028





CERTIFICATE No CF 5060

ASSA ABLOY LIMITED T/A LORIENT

LORIENT SYSTEM-36 PLUS GLAZING GASKETS

This Certificate of Approval relates to the contribution to fire resistance of the Lorient System-36/6 PLUS, 36/7 PLUS, 36/10 PLUS, 36/15 PLUS and 36/23 PLUS Glazing Gaskets used in timber screens and timber door leaves, for periods of 30 or 60 minutes integrity and/or insulation, as defined in BS 476: Part 22: 1987 subject to the undermentioned conditions.

This product is approved on the basis of:

- i) Initial type testing.
- ii) A design appraisal against TS25.
- iii) Certification of quality management system to ISO 9001: 2008.
- iv) Inspection and surveillance of factory production control.
- v) Audit testing.

This Certificate of Approval must be read in conjunction with CERTIFIRE Technical Schedule TS25, Fire Resistant Glass, Glazing Systems and materials.

- **Lorient System-36/6 PLUS Fire Resistant Glazing Gasket-** for use in doors and screens for periods of 30 minutes integrity
- **Lorient System-36/7 PLUS Fire Resistant Glazing Gasket-** for use in doors and screens for periods of 30 minutes integrity
- **Lorient System-36/10 PLUS Fire Resistant Glazing Gasket -** for use in doors and screens for periods of 30 minutes integrity
- **Lorient System-36/15 PLUS Fire Resistant Glazing Gasket -** for use in doors and screens for periods of 30 minutes integrity and insulation and also for use in doors and screens for 60 minutes integrity with 30 minutes insulation
- **Lorient System-36/23 PLUS Fire Resistant Glazing Gasket -** for use in screens for periods of 60 minutes integrity and insulation

Lorient System-36/6 PLUS, 36/7 PLUS, 36/10 PLUS, 36/15 PLUS and 36/23 PLUS glazing gasket system consists of three essential elements and a fourth depending upon application:

1. A flexible U-shaped intumescent gasket.
2. Retaining beads of a specific design
3. Pin or screw fixings, via the retaining beads
4. A sodium silicate based intumescent material, used as a lining around the perimeter of flaxboard substrates below 500 kg/m³ density

The system is used at the perimeter of a pane of fire resisting glass to provide an effective seal between the glass and substrate within a screen or door leaf.

This certification is provided to the client for their own purposes and we cannot opine on whether it will be accepted by Building Control authorities or any other third parties for any purpose.

Page 2 of 19 Signed
E/108

Issued: 4th July 2012
Revised: 1st March 2023
Valid to: 29th January 2028

CERTIFICATE No CF 5060 ASSA ABLOY LIMITED T/A LORIENT

LORIENT SYSTEM-36 PLUS GLAZING GASKETS

The figures below referenced LG1512, LG1513, LG1717, LG2022 and LG2229 show the dimensions of the System-36/6 PLUS, 36/7 PLUS, 36/10 PLUS, 36/15 PLUS and 36/23 PLUS Glazing Gaskets respectively. This shall be used in conjunction with the other elements listed above to form the complete system.

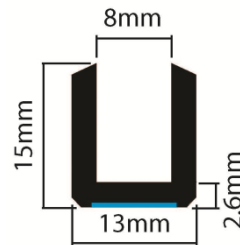
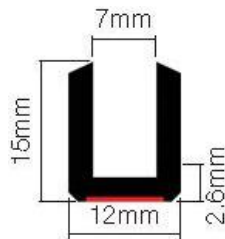

LG1512

LG1513

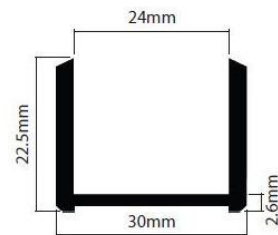
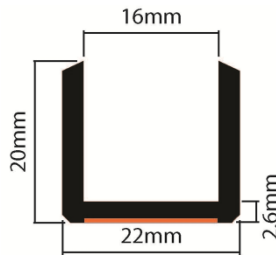
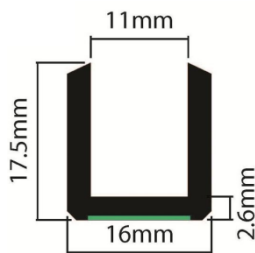

LG1717

LG2022

LG2229

CERTIFICATE No CF 5060 ASSA ABLOY LIMITED T/A LORIENT

LORIENT SYSTEM-36 PLUS GLAZING GASKETS

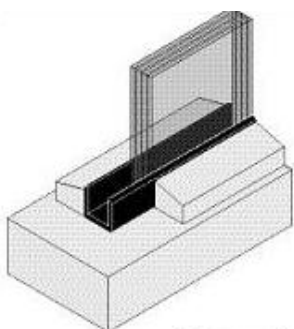

Figure 1

Figure 1 shows a typical arrangement of Lorient System-36/6 PLUS and 36/7 PLUS in a timber screen. The Gasket may be used with either pinned or screw-fixed retaining beads. Where screw fixings are required standard woodscrews should be used, No.8's, at maximum of 200mm fixing centres. Pins shall be a minimum of 40 mm long. For Pyrozet glass, 4 mm setting blocks should be used at the base of the aperture and 4 mm expansion allowance should be provided at head and each vertical edge.

Figure 2 shows a typical arrangement of Lorient System-36/6 PLUS or 36/7 PLUS Glazing Gasket in a timber door leaf. The Gasket may be used with either pinned or screw-fixed retaining beads. Where screw fixings are required standard woodscrews should be used, No.8's, at maximum of 200mm fixing centres. Pins shall be a minimum of 40 mm long when glazing with either System-36/6 PLUS or System-36/7 PLUS. For Pyrozet and Pyrotuf glass, 4 mm setting blocks should be used at the base of the aperture and 4 mm expansion allowance should be provided at head and each vertical edge.

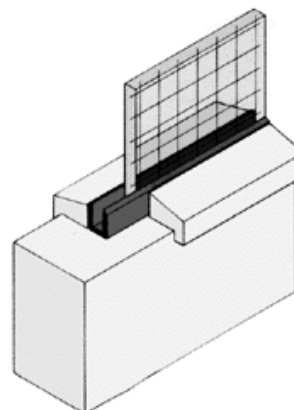

Figure 2

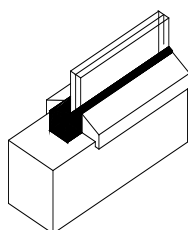

Figure 3

Figures 3 and 4 show a typical arrangement of Lorient System-36/10 PLUS Glazing Gasket in a timber door leaf and in a timber screen respectively. The Gasket shall be used with screw-fixed retaining beads, the screws shall be 45 mm long standard woodscrews, No.8's, at maximum of 200 mm fixing centres

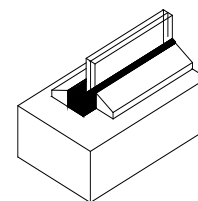

Figure 4

CERTIFICATE No CF 5060 ASSA ABLOY LIMITED T/A LORIENT

LORIENT SYSTEM-36 PLUS GLAZING GASKETS

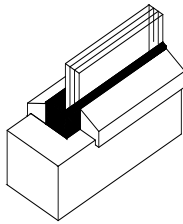

Figure 5

Figures 5 and 6 show a typical arrangement of Lorient System-36/15 PLUS glazing gasket in a timber door leaf and in a timber screen respectively. The Gasket shall be used with screw-fixed retaining beads, the screws shall be 45 mm long standard woodscrews, No.8's, at maximum of 200 mm fixing centres.

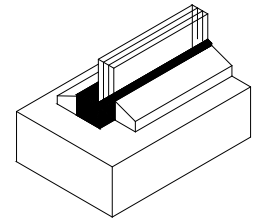

Figure 6

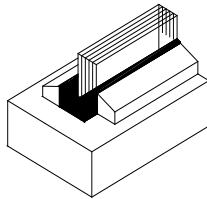

Figure 7

Figure 7 shows a typical arrangement of Lorient System-36/23 PLUS Glazing Gasket in a timber screen. The Gasket shall be used with screw-fixed retaining beads. The screw fixings are required to be standard No.8 wood screws, 45 mm long, at a maximum of 200mm fixing centres.

Variations in retaining bead profile are allowable for some of the above systems using alternative timber species, excluding Ash for 60 minute systems (see relevant section).

CERTIFICATE No CF 5060 ASSA ABLOY LIMITED T/A LORIENT

LORIENT SYSTEM-36 PLUS GLAZING GASKETS

Bead and Framing Specifications

System-36/6 PLUS and 36/7 PLUS applied to timber framed screens - for periods of 30 minutes integrity only

Figure 8 shows typical dimensions for framing members, as manufactured from softwood.

For softwood of lower density than 520 kg/m^3 , larger section sizes may be required. Where alternative timbers are required, other timbers of the same density or higher may be used at the same section size.

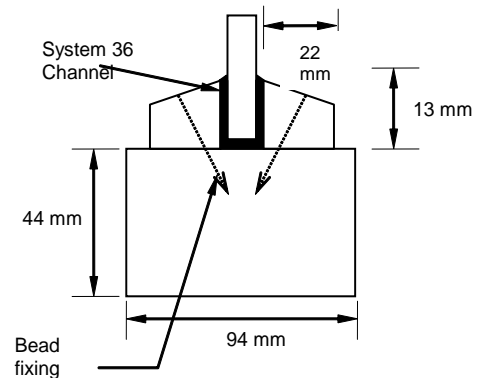

Figure 8

The tested size of the framing member was 90mm deep by 45mm high at 520 kg/m^3 density. The acceptable minimum size is 70mm deep by 33mm high at a minimum density of 520 kg/m^3 .

Hardwood retaining beads shall be of a minimum density 640 kg/m^3 .

Variations in retaining bead profile are allowable with or without bolection detail and using alternative timber species of minimum density 640 kg/m^3 , providing they fall within the 'Other Variations' section of this approval.

CERTIFICATE No CF 5060 ASSA ABLOY LIMITED T/A LORIENT

LORIENT SYSTEM-36 PLUS GLAZING GASKETS

System-36/6 PLUS and 36/7 PLUS applied to timber doors - for periods of 30 minutes integrity only

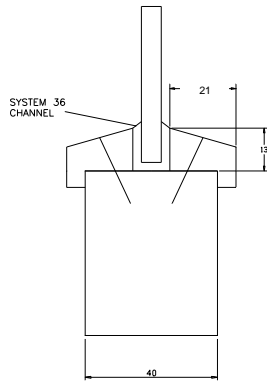

A secondary sodium silicate based intumescent material is required to be used as a lining around the perimeter of apertures cut within flaxboard substrates which have a density below 500 kg/m³.

Hardwood retaining beads shall be of a minimum density 600 kg/m³.

Variations in retaining bead profile are allowable with or without bolection detail and using alternative timber species of minimum density 600 kg/m³.

CERTIFICATE No CF 5060 ASSA ABLOY LIMITED T/A LORIENT

LORIENT SYSTEM-36 PLUS GLAZING GASKETS

System-36/10 PLUS applied to timber framed screens - for periods of 30 minutes integrity only

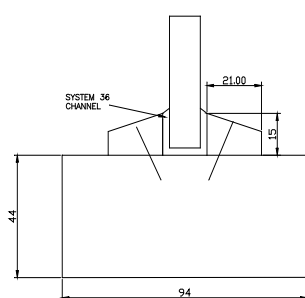

Figure 11

Figure 11 shows the minimum dimensions for framing members, as manufactured from softwood at 520 kg/m³ density.

Softwood of lower density than 520 kg/m³ should not be used. Where alternative timbers are required, other timbers of the same density or higher may be used at the same section size.

Softwood or hardwood retaining beads shall be of a minimum density 550 kg/m³.

Variations in retaining bead profile are allowable with or without bolection detail and using alternative timber species of minimum density 550 kg/m³, including Oak, Beech, Ramin, Columbian Pine and Utile (subject to minimum density). The bead height shall be exactly 15 mm, the bead width shall be a minimum of 21 mm.

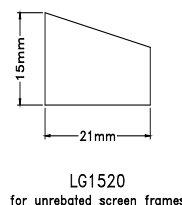

Figure 12

CERTIFICATE No CF 5060 ASSA ABLOY LIMITED T/A LORIENT

LORIENT SYSTEM-36 PLUS GLAZING GASKETS

System-36/10 PLUS applied to timber based door leaves - for periods of 30 minutes integrity only

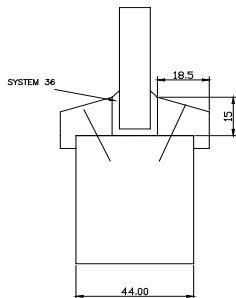
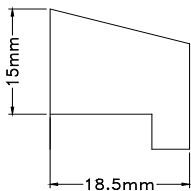

Figure 13

Figure 13 shows the minimum dimensions for glazing into timber door leaves.

This Certificate of Approval relates to the following glasses when used in conjunction with System-36/10 Glazing Gaskets methods at the maximum sizes shown in Table 2 on page 16.



LG1521
for 44mm thick doors or
rebated screen frames

Figure 14

Softwood or hardwood retaining beads shall be of a minimum density 550 kg/m^3 .

Variations in retaining bead profile are allowable using alternative timber species of minimum density 550 kg/m^3 , including Oak, Beech, Ramin, Columbian Pine and Utile (subject to minimum density). The bead height shall be exactly 15 mm, the bead width shall be a minimum of 18.5 mm.

CERTIFICATE No CF 5060 ASSA ABLOY LIMITED T/A LORIENT

LORIENT SYSTEM-36 PLUS GLAZING GASKETS

System-36/15 PLUS applied to timber framed screens - for periods of 30 minutes integrity and 30 minutes insulation

Figure 15 shows the minimum dimensions for framing members, as manufactured from softwood. Softwood of lower density than 520 kg/m^3 should not be used. Where alternative timbers are required, other timbers of the same density or higher may be used at the same section size.

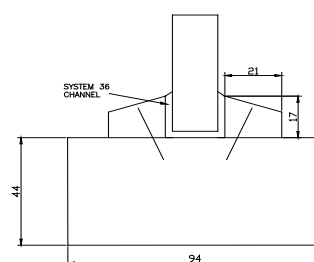

Figure 15

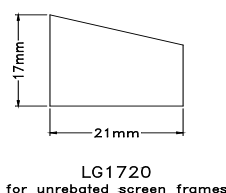

Figure 16

Softwood or hardwood retaining beads shall be of a minimum density 550 kg/m^3 .

Variations in retaining bead profile are allowable using alternative timber species of minimum density 550 kg/m^3 , including Oak, Beech, Ramin, Utile and Columbian Pine (subject to minimum density). The bead height shall be exactly 17 mm, the bead width shall be a minimum of 21 mm.

CERTIFICATE No CF 5060 ASSA ABLOY LIMITED T/A LORIENT

LORIENT SYSTEM-36 PLUS GLAZING GASKETS

System-36/15 PLUS applied to timber framed screens - for periods of 60 minutes integrity and 30 minutes insulation

Figure 17 shows the minimum dimensions for framing members, as manufactured from hardwood of density 550 kg/m³. Lower density timber should not be used. Where alternative timbers are required, other timbers of the same density or higher may be used, excluding Ash, at the same minimum section size.

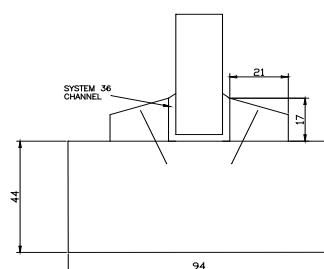

Figure 17

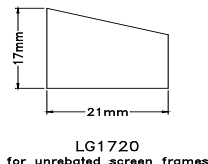

Figure 18

Hardwood retaining beads shall be of a minimum density 550 kg/m³.

Variations in retaining bead profile are allowable using alternative timber species of minimum density 550 kg/m³, including Oak, beech, Ramin and Utile (subject to minimum density). The bead height shall be exactly 17 mm, the bead width shall be a minimum of 21 mm.

CERTIFICATE No CF 5060 ASSA ABLOY LIMITED T/A LORIENT

LORIENT SYSTEM-36 PLUS GLAZING GASKETS

System-36/15 PLUS applied to timber based door leaves - for periods of 30 minutes integrity and insulation

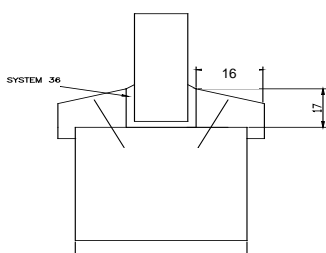

Figure 19

Figure 19 shows the minimum dimensions for glazing into timber door leaves.

This Certificate of Approval relates to the following glasses when used in conjunction with System-36/15 PLUS Glazing Gaskets methods at the maximum sizes shown in Table 2 on page 16

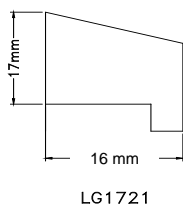

Figure 20

Softwood or hardwood retaining beads shall be of a minimum density 550 kg/m³.

Variations in retaining bead profile are allowable using alternative timber species of minimum density 550 kg/m³, including Oak, Beech, Ramin, Utile and Columbia Pine (subject to minimum density). The bead height shall be exactly 17 mm, the bead width shall be a minimum of 16 mm.

CERTIFICATE No CF 5060 ASSA ABLOY LIMITED T/A LORIENT

LORIENT SYSTEM-36 PLUS GLAZING GASKETS

System-36/15 PLUS applied to timber based door leaves - for periods of 60 minutes integrity and 30 minutes insulation

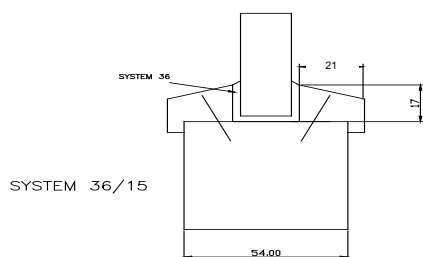

Figure 21

Figure 21 shows the minimum dimensions for glazing into timber door leaves.

This Certificate of Approval relates to the following glasses when used in conjunction with System-36/15 Plus Glazing Gaskets methods at the maximum sizes shown in Table 2 on page 16.

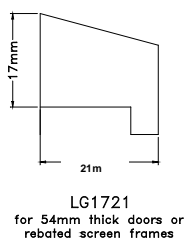

Figure 22

Hardwood retaining beads shall be of a minimum density 550 kg/m^3 .

Variations in retaining bead profile are allowable using alternative timber species of minimum density 550 kg/m^3 , including Oak, Beech, Ramin and Utile but excluding Ash (subject to minimum density). The bead height shall be exactly 17 mm, the bead width shall be a minimum of 21 mm.

CERTIFICATE No CF 5060 ASSA ABLOY LIMITED T/A LORIENT

LORIENT SYSTEM-36 PLUS GLAZING GASKETS

System-36/23 PLUS applied to timber framed screens - for periods of 60 minutes integrity and 60 minutes insulation

Figure 23 shows the minimum dimensions for framing members, as manufactured from Utile hardwood of nominal density 550 kg/m³. The tested size of the framing member was 90mm deep by 44mm. Lower density timbers should not be used. Where alternative timbers are required, other timbers of the same density or higher may be used. Ash is not able to be used.

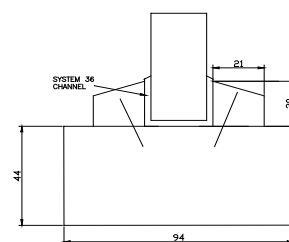

Figure 23

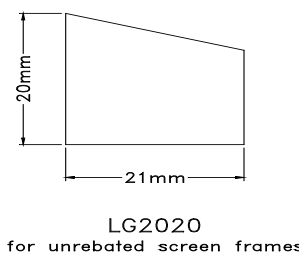

Figure 24

Hardwood retaining beads shall be of a minimum density 550 kg/m³.

Variations in retaining bead profile are allowable using alternative timber species of minimum density 550 kg/m³, including Oak, Beech, Ramin and Utile but excluding Ash (subject to minimum density). The bead height shall be exactly 20mm, the bead width shall be a minimum of 21mm.



CERTIFICATE No CF 5060 ASSA ABLOY LIMITED T/A LORIENT

LORIENT SYSTEM-36 PLUS GLAZING GASKETS

System-36/6 PLUS, 36/7 PLUS, 36/10 PLUS, 36/15 PLUS and 36/23 PLUS applied to timber framed screens

This Certificate of Approval relates to the following glasses when used in conjunction with System-36/6 PLUS, 36/7 PLUS, 36/10 PLUS, 36/15 PLUS and 36/23 PLUS Glazing Gaskets at the maximum sizes shown in Table 1 below:

Table 1 - Acceptable glass sizes for screens

Glass	Fire Performance – Integrity/Insulation (minutes)	Glazing System-	Maximum Pane Height (mm)	Maximum Pane Width (mm)	Maximum Pane Area (m ²)
Pyroshield 2	30/0	36/6/7 PLUS	2530	1019	2.34
Firelite	30/0	36/6 PLUS	2530	1019	2.34
Pyran S (6, 8, 10 mm)	30/0	36/6/7/10 PLUS	2530	1019	2.34
Pyrostem (7 mm)	30/0	36/7 PLUS	2530	1019	2.34
Pyrocet	30/0	36/6 PLUS	1732	829	1.15
Pyroguard C / W 7 mm	30/0	36/7 PLUS	2300	926	2.13
Pyroguard C/W 11 mm	30/0	36/10 PLUS	2300	926	2.13
Pyrobelite 7	30/0	36/7 PLUS	2875	1157	2.66
Pyrobel 16	60/30	36/15 PLUS	2000	1378	1.90
Pyrobel 16	30/30	36/15 PLUS	2000	1378	1.90
Pyrodur PLUS	30/0	36/7 PLUS	2320	1082	2.50
10 mm Pyrodur	30/0	36/10 PLUS	2000	1378	1.90
15 mm Pyrostop	30/30	36/15 PLUS	2000	1378	1.90
15 mm Pyrostop	60/30	36/15 PLUS	2000	1378	1.90
23 mm Pyrostop	60/60	36/23 PLUS	2000	1342	1.80
Pyranova 30 S2.0	30/30	36/15 PLUS	2000	1378	1.90
Pyranova 60 S2.0	60/60	36/23 PLUS	2000	1342	1.80
Pyranova 30 S3.0	60/30	36/15 PLUS	1830	610	0.92
Pyranova 30 S3.0	30/30	36/15 PLUS	2000	1378	1.90
Pyranova 60 S3.0	60/60	36/23PLUS	2000	1342	1.80
Pyroguard Insulation 30-15	30/30	36/15 PLUS	2000	1378	1.90
Pyroguard Insulation 60-23	60/60	36/23 PLUS	2000	1342	1.80
Contraflam 30	30/30	36/15 PLUS	2445	1420	3.47

The above table applies to softwood and/or hardwood framed screens (specification subject to fire performance and detailed in previous sections), including multi-paned assemblies with shared Mullions and transoms.

Page 15 of 19 Signed
E/108

Issued: 4th July 2012
Revised: 1st March 2023
Valid to: 29th January 2028

CERTIFICATE No CF 5060 ASSA ABLOY LIMITED T/A LORIENT

LORIENT SYSTEM-36 PLUS GLAZING GASKETS

System-36/6 PLUS, 36/7 PLUS, 36/10 PLUS and 36/15 PLUS applied to timber based door leaves

This Certificate of Approval relates to the following glasses when used in conjunction with System-36/6 PLUS, 36/7 PLUS, 36/10 PLUS and 36/15 PLUS Glazing Gaskets methods at the maximum sizes shown in Table 2 below:

Table 2 - Acceptable glass sizes for door leaves

Glass	Fire Performance – Integrity/Insulation (minutes)	Glazing System	Maximum Pane Height (mm)	Maximum Pane Width (mm)	Maximum Pane Area (m ²)
Pyroshield 2	30/0	36/6/7 PLUS	1482	580	0.688
Firelite	30/0	36/6 PLUS	1482	580	0.688
Pyran S (6, 8, 10 mm)	30/0	36/6/7/10 PLUS	1482	580	0.688
Pyrostem (7 mm)	30/0	36/7 PLUS	1482	580	0.688
Pyrocet	30/0	36/6 PLUS	1482	580	0.688
Pyrotuf	30/0	36/6 PLUS	1300	506	0.598
Pyroguard C / W 7 mm	30/0	36/7 PLUS	875	750	0.66
Pyroguard C / W 11 mm	30/0	36/10 PLUS	1353	870	0.95
Pyrobelite 7	30/0	36/7 PLUS	1800	600	1.08
Pyrobel 16	60/30	36/15 PLUS	1800	600	1.08
Pyrobel 16	30/30	36/15 PLUS	1800	600	1.08
Pyrodur PLUS	30/0	36/7 PLUS	875	750	0.66
10 mm Pyrodur	30/0	36/10 PLUS	1800	600	1.08
15 mm Pyrostop	60/30	36/15 PLUS	1790	630	1.11
Pyranova 15 S2.0 (11mm)	30/0	36/10 PLUS	1800	600	1.08
Pyranova 30 S2.0	30/30	36/15 PLUS	1800	600	1.08
Pyranova S3.0.7	30/0	36/7 PLUS	1550	517	0.775
Pyranova 30 S3.0	60/30	36/15 PLUS	1830	610	0.92
Pyranova 30 S3.0	30/30	36/15 PLUS	1875	625	0.94
Pyroguard Insulation 30-15	30/30	36/15 PLUS	1800	600	1.08

This Certificate of Approval relates to timber based door leaf constructions consisting of timber faces coupled with timber or other cellulosic cores of not less than 40mm (for 30 minutes) and 54 mm (for 60 minutes) overall leaf thickness.

Page 16 of 19 Signed
E/108



Issued: 4th July 2012
Revised: 1st March 2023
Valid to: 29th January 2028



CERTIFICATE No CF 5060

ASSA ABLOY LIMITED T/A LORIENT

LORIENT SYSTEM-36 PLUS GLAZING GASKETS

The System-36 PLUS glazing gaskets may be fitted in the manner described in this Certificate of Approval, to previously tested door leaves provided that the particular aspects of the door assembly are maintained. These are described below but are not exhaustive:

1. The doorset, including door frame and associated building hardware, should have achieved at least 30 or 60 minutes (whichever is applicable) integrity when tested or subsequently assessed by one of the laboratories approved by CERTIFIRE as acceptable for this purpose to BS 476: Part 22: 1987.
2. If the proposed doorset is to be used in double-leaf configuration, the test or assessment evidence should be applicable to double-leaf configurations.
3. Likewise, if the proposed doorset is to be used in the unlatched configuration the available evidence should be applicable to unlatched doorsets.
4. The proposed doorset should also have included a glazed aperture or apertures of the intended size, shape, area and number.
5. When used to glaze CERTIFIRE approved doorsets which have smaller apertures than allowed in this certificate, the aperture sizes specified in the doorset certificate shall take precedence.

In this way the proposed installation of the Lorient System-36 PLUS glazing gaskets is not expected to affect the performance of the leaf.

Variations in retaining bead profile are allowable with or without bolection detail and using alternative timber species of minimum density 600 kg/m³, (excluding Ash for 60 minute applications) providing they fall within the limits given in the section headed 'Beads' on page 19.

CERTIFICATE No CF 5060 ASSA ABLOY LIMITED T/A LORIENT

LORIENT SYSTEM-36 PLUS GLAZING GASKETS

Other Variations

Shapes

It is also acceptable to include System-36/6 PLUS and 36/7 PLUS Glazing Gaskets in shaped apertures, as shown in Figure 25, within timber door leaves. Where shaped apertures are included, only finger jointed glazing beads are acceptable

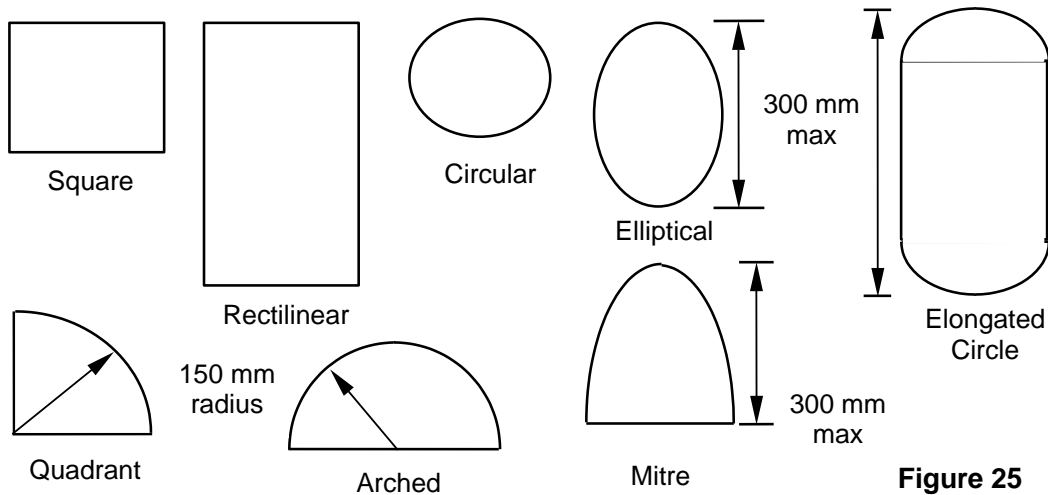

Figure 25

CERTIFICATE No CF 5060 ASSA ABLOY LIMITED T/A LORIENT

LORIENT SYSTEM-36 PLUS GLAZING GASKETS

Beads

Variations in bead size and shape are allowable on the basis that they present less risk with regard to ignition of the beads due to emitted heat radiation. The acceptable bead types are shown in Figure 26.

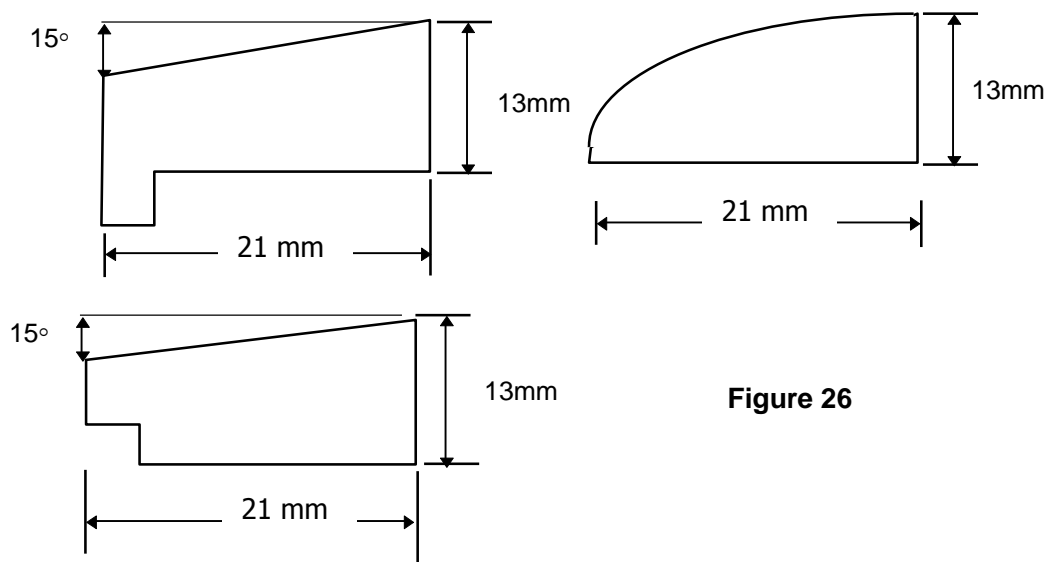

Figure 26

This approval relates to on-going production. Product and/or its immediate packaging is identified with the manufacturer's name, the product name or number, the CERTIFIRE name or name and mark, together with the CERTIFIRE certificate number and application when appropriate.

For fully insulated glass types, and 10 mm Pyrodur, square bead are also acceptable.