

 **LORIENT**

ASSA ABLOY

ARCHITECTURAL
SEALS

ARCHITECTURAL
TECTU
SEALS





We've been designing and manufacturing high performance sealing systems for over 45 years.

And we're passionate about the products we make. Our dedicated R+D and testing facilities rigorously put our sealing systems through their paces – enabling us to enhance product form and function. We've built a strong reputation for design innovation; and for producing the highest quality sealing systems embracing acoustic, smoke, fire and thermal containment; as well as accessibility.

Respected throughout the industry for our technical expertise, we play an active role in helping to shape standards and best practice. We believe in providing excellent levels of customer service; and are at our best working in partnership with you.

The Lorient Architectural Seals range incorporates a variety of complementary door sealing systems including perimeter seals, drop seals, threshold plates, door bottom seals plus much more. These seals can provide outstanding protection for all four sides of the door against sound, smoke, fire, rain, light, and draughts.

Manufactured to the highest quality standards, Lorient Architectural Seals have been designed and tested for a host of different applications in a variety of sectors throughout commercial, industrial and public buildings.

**MADE IN
BRITAIN** 

SEALING DOORS WORLDWIDE

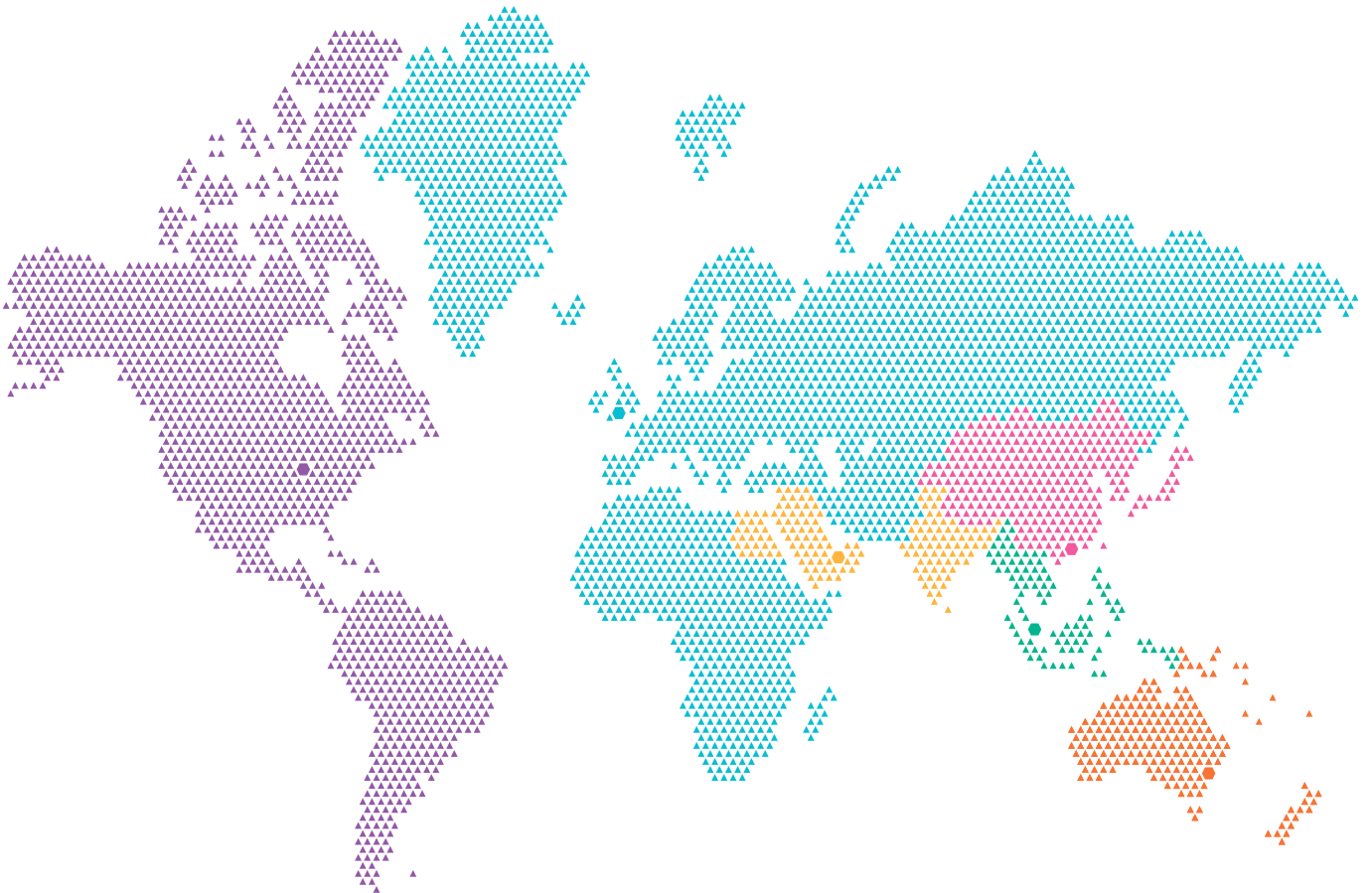

The UK is home to our head office, manufacturing operation and dedicated R&D testing facility. Our UK & Europe head office supports operations around the world, delivering the best solutions locally to our customers across four continents.

By keeping abreast of technical developments and changes to regulations and standards across the world, we deliver the highest levels of expertise and support.

 UNITED KINGDOM (HQ)

 AUSTRALIA

 SINGAPORE

 HONG KONG

 USA

 UAE

LORIENT ARCHITECTURAL SEALS

CONTENTS

01

Introduction

02

Sealing Doors Worldwide

04 – 07

Product Range

08

Life Threatening Forces

09

High Performance Sealing Systems

10

Building Regulations

11

Standards + Regulations

12 – 19

Compression Seals

20 – 27

Door Bottom Seals

28 – 36

Threshold Plates + Ramps

37 – 41

Brush Seals

42 – 44

Magnetic Seals

45 – 47

Meeting Stile Seals

48 – 59

Perimeter Seals

60 – 74

Drop Seals

75 – 79

Finger Guard /
Speciality Seals

80

CPD Seminars

82

Additional Information

84

Comprehensive Support

85

Maintenance Guide

86

Testing + Technical Services

87

Sealing Solutions



COMPRESSION SEALS

(PAGES 12–19)

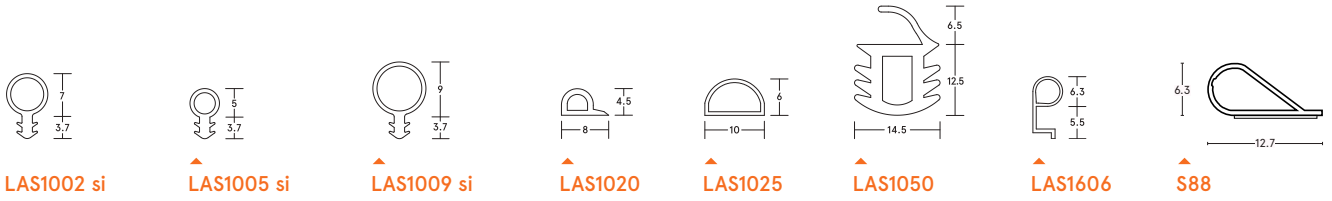

DOOR BOTTOM SEALS

(PAGES 20–27)

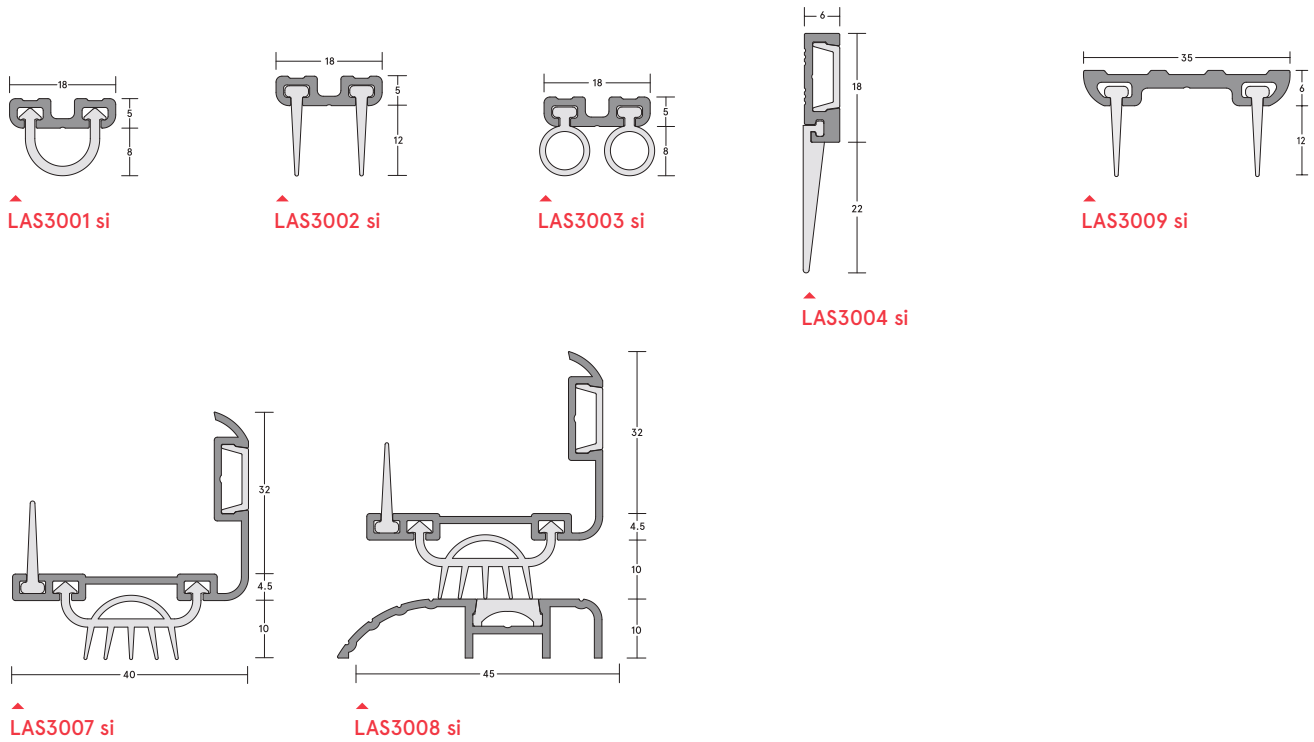

PERIMETER SEALS

(PAGES 48–59)

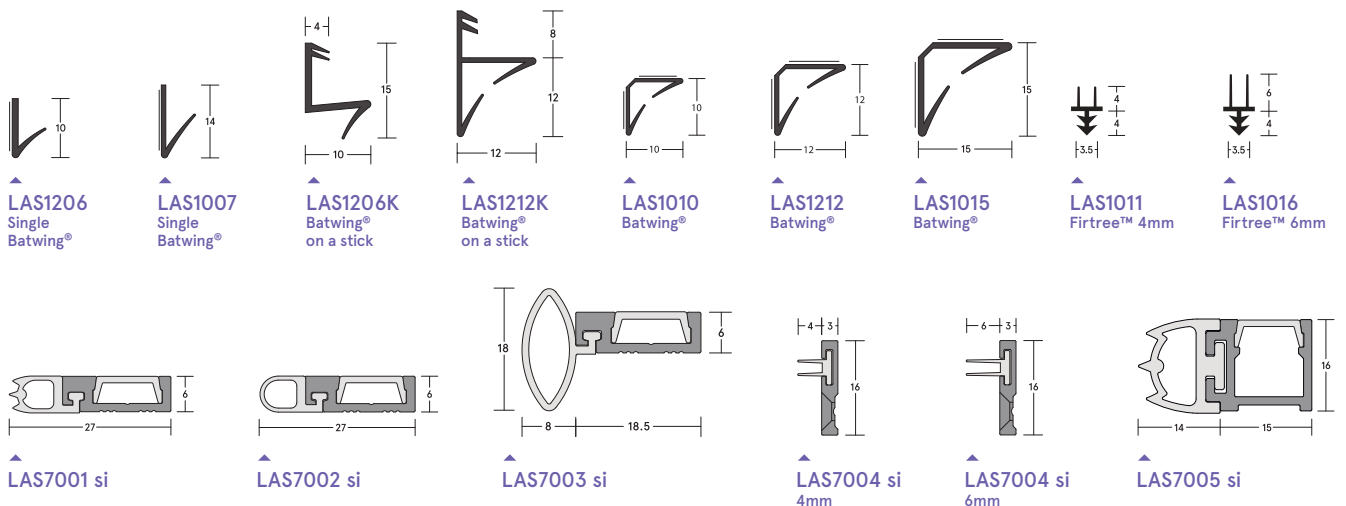

THRESHOLD PLATES + RAMPS

(PAGES 28–36)

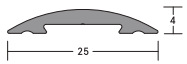

LAS4001

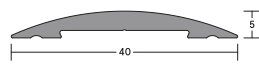

LAS4002

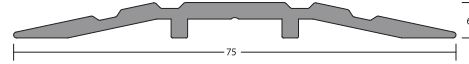

LAS4010

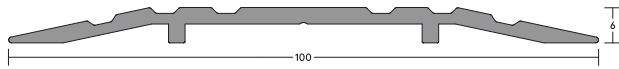

LAS4011

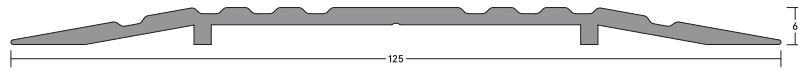

LAS4012

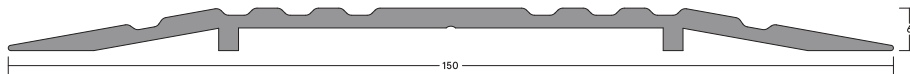

LAS4013

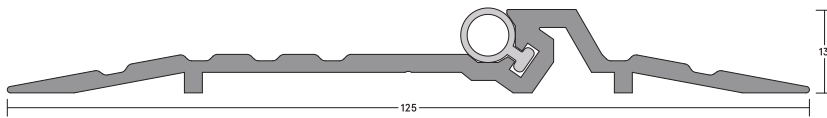

LAS4014 si

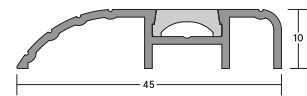

LAS4015

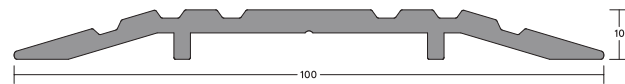

LAS4100

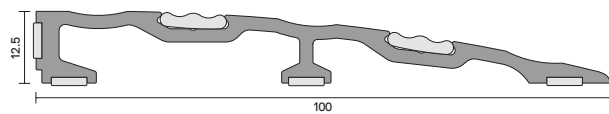

AAS4551

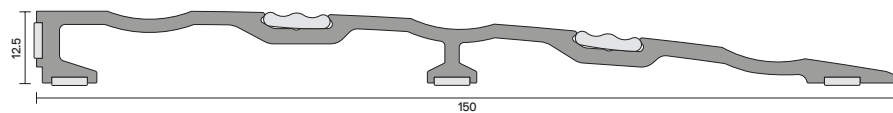

AAS4552

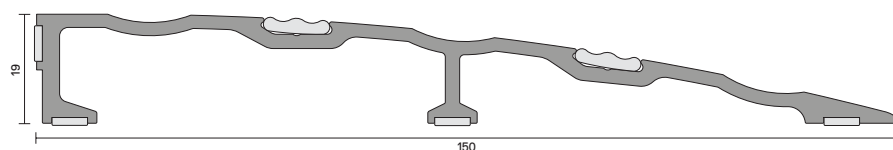

AAS4553

BRUSH SEALS

(PAGES 37–41)

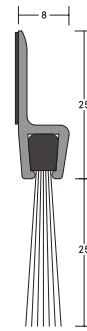

LAS5020

Also available

- LAS5010 (13mm brush)
- LAS5015 (19mm brush)
- LAS5025 (35mm brush)
- LAS5030 (45mm brush)

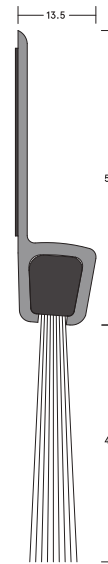

LAS5035

Also available

- LAS5040 (60mm brush)
- LAS5045 (80mm brush)
- LAS5050 (120mm brush)
- LAS5055 (150mm brush)

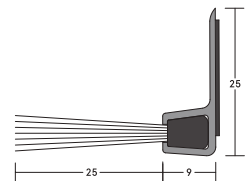

LAS5060

Also available

- LAS5065 (35mm brush)
- LAS5070 (45mm brush)

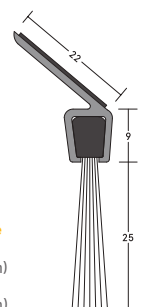

LAS5075

Also available

- LAS5080 (35mm brush)
- LAS5085 (45mm brush)

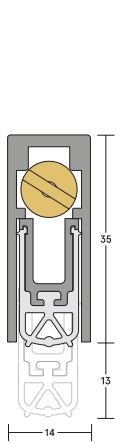

▲ AAS8501 si

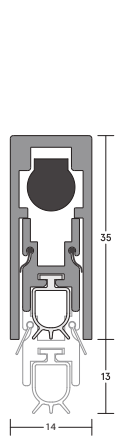

▲ LAS8001 si
LAS8002 si

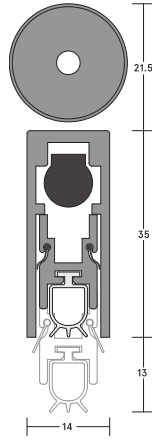

▲ LAS8001M

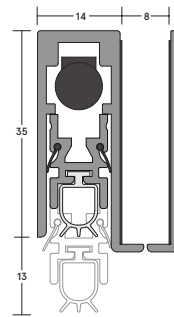

▲ LAS8002G si
Left + right handed
variants available

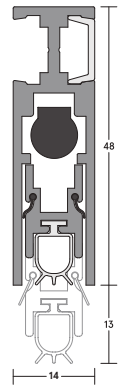

▲ LAS8003 si

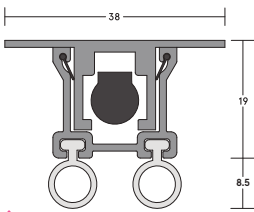

▲ LAS8004 si

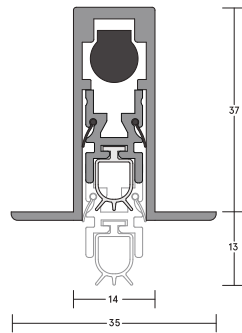

▲ LAS8005 si

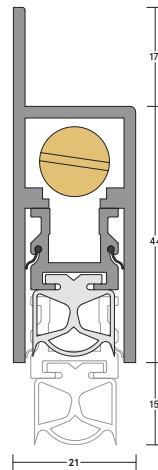

▲ LAS8006 si

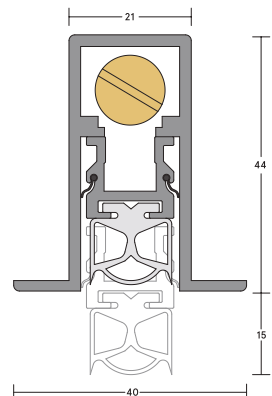

▲ LAS8007 si

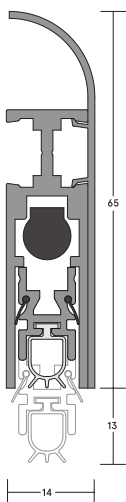

▲ LAS8008 si

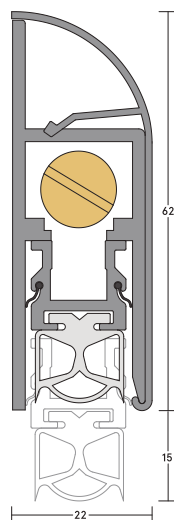

▲ LAS8009 si

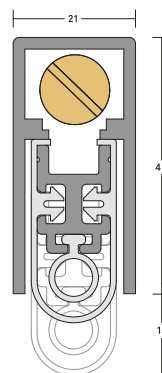

▲ LAS8014 si

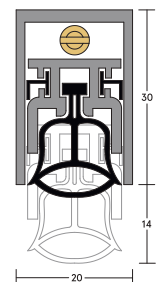

▲ LAS8040

MAGNETIC SEALS (PAGES 42–44)

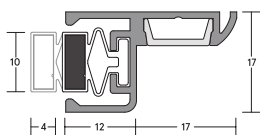

▲ LAS6001



▲ LAS6011

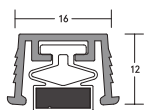

▲ LAS6002

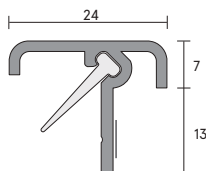

▲ LAS7006

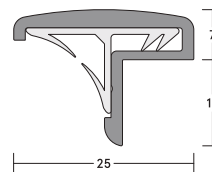

▲ AAS7506

FINGER GUARDS / SPECIALITY SEALS (PAGES 75–79)

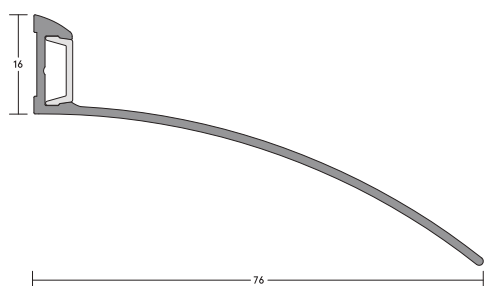

▲ LAS9001



▲ LAS9030

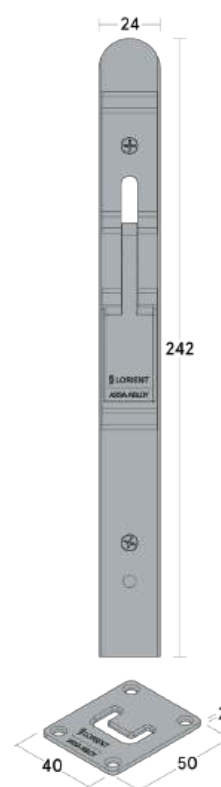

▲ LAS9010

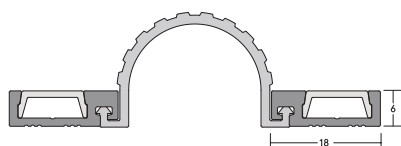

▲ LAS9050 si

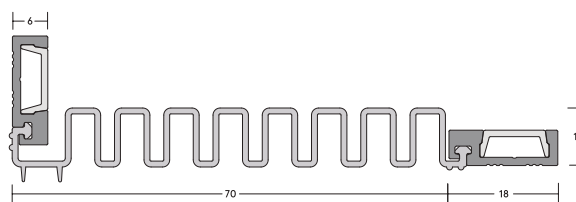

▲ LAS9070 si

PRODUCT ILLUSTRATIONS

All dimensions in this brochure are in millimetres.

LIFE THREATENING FORCES

On average 216 people are killed and 5,454 are injured* in fires each year in the UK alone. Many of the casualties are attributable to breathing the toxic products of combustion from a remote fire.



England 2022/23. Source: Home Office 2024.

Design Needs and Regulatory Requirements

When fire breaks out in a building the threat is twofold. Firstly, there is the fire itself and the hot smoke generated in the immediate vicinity. Secondly, there is cold smoke which will spread rapidly through the building, threatening people and property some distance from the fire. The Building Regulations take both these threats into account, and supporting documents give criteria for how they can be managed. Details can be found in Approved Document B (England & Wales), Technical Booklet E (N Ireland), and Technical Handbook Section 2 (Scotland).

The Regulations require large buildings to be divided into smaller fire and smoke resistant 'compartments', to reduce the risk of damage to the

building as a whole and also to save lives in the case of a fire. Building a fire resistant wall or floor to make a compartment is relatively simple. However, building design becomes much more complex when the compartments need to be linked in some way – essential to make the building usable. Every time an aperture is cut into one of the compartment boundaries (for example, to install a door in a fire resistant wall, or to pass ductwork through a wall or ceiling) the aperture must be filled with something that will preserve the fire and smoke integrity of the compartment.

That's the role of Lorient's products – to work with the surrounding elements of the building to preserve the integrity of the fire and smoke resistant compartments.

Our fire and smoke seals can be fitted into fire rated doors; our glazing products can be fitted into doors, screens or fire rated partitions; our air transfer grilles can be installed into doors, walls and ducts.

Fire and smoke protection products must be tested to prove their performance, and indeed, separate tests are required for fire and smoke. Our products are all extensively tested, and our test reports are freely available on request.



Call our Technical Services team

+44 (0) 1626 834252

www.lorientuk.com

HIGH PERFORMANCE SEALING SYSTEMS

Today's architectural door assembly is heavily dependent on sealing systems for its performance; be that fire, smoke, acoustic or thermal containment. In choosing the right sealing solution, it's essential to make sure it's compatible with the door assembly.

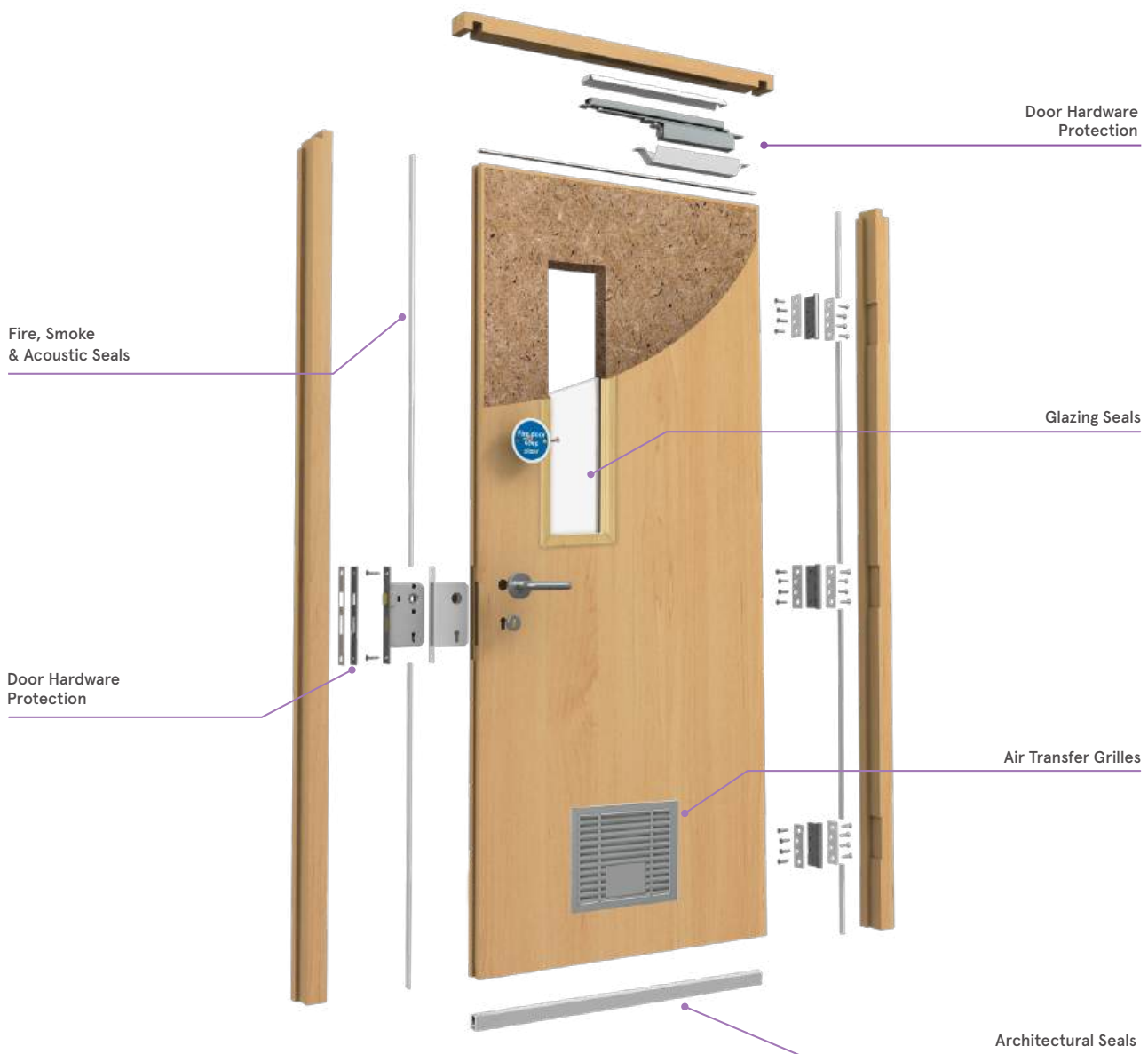

BUILDING REGULATIONS

The Building Regulations provide guidance as to the minimum building standards to be achieved. They reference the relevant British and European Standards defining the test requirements and performance of the fire door assembly or fire doorset.

There are several aspects of the Buildings Regulations that must be considered in conjunction with each other when specifying and installing fire resistant glazing systems. The regional variations of the Building Regulations:

ENGLAND	Approved Documents
WALES	Approved Documents
SCOTLAND	Technical Handbooks
N.IRELAND	Technical Booklets
IRELAND	Technical Documents

	ENGLAND	WALES	SCOTLAND	N.IRELAND	IRELAND
FIRE	Approved Document B	Approved Document B	Technical Handbook 2	Technical Booklet E	Technical Guidance Document B
ACOUSTICS	Approved Document E	Approved Document E	Technical Handbook 5	Technical Booklet G	Technical Guidance Document E
ACCESSIBILITY	Approved Document M	Approved Document M	Technical Handbook 3	Technical Booklet R	Technical Guidance Document M
VENTILATION	Approved Document F	Approved Document F	Technical Handbook 3	Technical Booklet K	Technical Guidance Document F
THERMAL	Approved Document L	Approved Document L	Technical Handbook 6	Technical Booklet F	Technical Guidance Document L
SECURITY	Approved Document Q	Approved Document Q	-	-	-

STANDARDS + REGULATIONS

The requirements for fire and smoke containment with regard to 'means of escape' are contained in the following standards:

FIRE + SMOKE

STANDARD	TITLE
BS 476-20:1987	Fire tests on building materials and structures. Method for determination of the fire resistance of elements of construction (general principles)
BS 476-22:1987	Methods for determination of the fire resistance of non-loadbearing elements of construction
BS 476-31.1:1983	Fire tests on building materials and structures. Methods for measuring smoke penetration through doorsets and shutter assemblies. Method of measurement under ambient temperature conditions
BS EN 1634-3:2004	Fire resistance and smoke control tests for door and shutter assemblies, openable windows and elements of building hardware. Smoke control test for door and shutter assemblies
BS EN 1634-1:2014+A1:2018	Fire resistance and smoke control tests for door and shutter assemblies, openable windows and elements of building hardware. Smoke control test for door and shutter assemblies
BS 8214:2016	Code of practice for fire door assemblies
BS 8214:2016	Code of practice for fire safety in the design, management and use of buildings

ACOUSTIC

STANDARD	TITLE
BS EN ISO 10140-1:2021	Acoustics. Laboratory measurement of sound insulation of building elements. Application rules for specific products
BS EN ISO 717-2:2020	Acoustics. Rating of sound insulation in buildings and of building elements. Impact sound insulation elements of construction
ASTM E413-16	Classification for Rating Sound Insulation

COMPRESSION SEALS

A variety of durable, flexible and lightweight seals that are easy to fit to the perimeter of timber doors and window frames.

Compression seals are ideal for new build or retrofit applications.

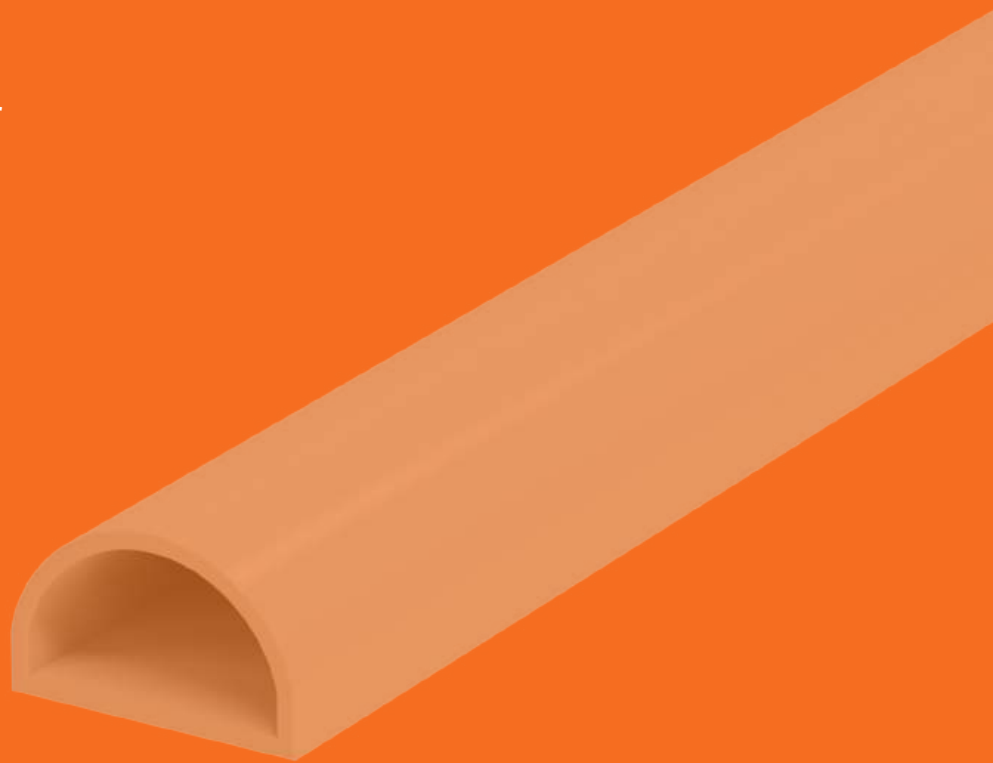

COMPRESSION SEALS

LAS1002 si, LAS1005 si & LAS1009 si

KERF-FIT **30dB**

Durable, kerf-fitting bulb seals of varying sizes for doors and window frames, which provide a compression seal. Lightweight and flexible. Quick and easy installation.



▲ LAS1005 si ▲ LAS1002 si ▲ LAS1009 si



▲ LAS1002 si

COMPRESSION SEALS

SYSTEM SPECIFICATIONS

Test evidence

- ▶ Acoustic: BS EN ISO 10140-2: 2010 (up to Rw 30dB).

Characteristics

- ▶ Contributes towards sound, weather, draught, and light containment.

Location

- ▶ Head and jambs of single swing doors.

Use with

- ▶ Practically any threshold seal.

Min/max gap size

- ▶ LAS1005 - 3mm/4mm.
- ▶ LAS1002 - 4mm/6mm.
- ▶ LAS1009 - 5mm/8mm.

Seal material

- ▶ Flexible silicone rubber.

Standard lengths

- ▶ 100m reels.
- ▶ Subject to MOQs.

Fixing

- ▶ Interference fit into a kerf 2mm wide and minimum 4mm deep.

Colours

- ▶ Grey, dark brown or black. Other colours available on request.

COMPRESSION SEALS

LAS1020

FACE-FIXED

A superior quality, self-adhesive door and window frame strip, designed to protect your home against noise, drafts, insects and weather ingress. Flexible and lightweight, the 'P' shape design allows for easy installation and a secure fit, making it an ideal choice for a wide range of applications.



▲ LAS1020

COMPRESSION SEALS



▲ LAS1020

SYSTEM SPECIFICATIONS

Characteristics

- ▶ Contributes towards sound, weather, draught, and light containment.

Location

- ▶ Mounted on the doorstep for single swing doors.

Use with

- ▶ Practically any threshold seal.

Min/max gap size

- ▶ 3mm/4mm.

Seal material

- ▶ Cellular rubber.

Standard lengths

- ▶ 6m rolls.
- ▶ Subject to MOQs.

Fixing

- ▶ Self-adhesive tape.
- ▶ Note: contact surfaces must be clean, smooth and, if painted, well cured.

Colours

- ▶ White or brown.

COMPRESSION SEALS

LAS1025

FACE-FIXED

Superior quality, self-adhesive profile for door and window frames, which provide an acoustic compression seal. Lightweight and flexible. Quick and easy installation.



LAS1025



LAS1025

COMPRESSION SEALS

SYSTEM SPECIFICATIONS

Characteristics

- ▶ Contributes towards sound, weather, draught, and light containment.

Location

- ▶ Mounted on doorstep or can be recessed by up to 2mm on single swing doors.

Use with

- ▶ Practically any threshold seal.

Min/max gap size

- ▶ 3mm/4mm (rebated).
- ▶ 3mm/5.5mm (non-rebated).

Seal material

- ▶ Co-extruded elastomeric bulb with PVC spine.

Standard lengths

- ▶ 1m and 2.1m lengths.
- ▶ Subject to MOQs.

Fixing

- ▶ Self-adhesive tape.
- ▶ Note: contact surfaces must be clean, smooth and, if painted, well cured.

Colours

- ▶ White or brown.

COMPRESSION SEALS

LAS1050

KERF-FIT **45dB**

Durable, silicone compression seal for acoustic performance. Seal push fits quickly and easily into a 12mm wide x 12mm deep groove. No mechanical fixings/screws required.

COMPRESSION SEALS

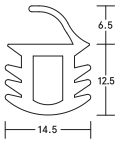

▲ LAS1050



▲ LAS1050

SYSTEM SPECIFICATIONS

Test evidence

- ▶ Acoustic: BS EN ISO 10140-2: 2010 (up to Rw 45dB).

Characteristics

- ▶ Contributes towards sound, weather, draught, and light containment.

Location

- ▶ Head and jambs of single swing doors.

Use with

- ▶ Practically any threshold seal.

Min/max gap size

- ▶ 2mm/4mm.

Seal material

- ▶ Flexible silicone rubber.

Standard lengths

- ▶ 100m reels.
- ▶ Subject to MOQs.

Fixing

- ▶ Interference fit into 12mm x 12mm preformed steel door frame rebate.

Colours

- ▶ Dark grey or black (non-UL).

Certification



(R27972)

COMPRESSION SEALS

LAS1060

KERF-FIT

Durable, kerf-fitting bulb seal for doors and window frames, which provides a compression seal. Lightweight and flexible. Quick and easy installation.



LAS1060



LAS1060

COMPRESSION SEALS

SYSTEM SPECIFICATIONS

Characteristics

- ▶ Contributes towards sound, weather, draught, and light containment.

Location

- ▶ Head and jambs of single swing doors.

Use with

- ▶ Most Lorient architectural seals.

Min/max gap size

- ▶ 3mm/6mm.

Seal material

- ▶ Flexible elastomer rubber.

Standard lengths

- ▶ 40m reels.
- ▶ Subject to MOQs.

Fixing

- ▶ Interference fit into a kerf 3mm wide and minimum 5mm deep.

Colours

- ▶ Dark brown or black.

COMPRESSION SEALS

LAS1606

KERF-FIT

A light-weight bulb type buffer seal with a semi-rigid spine for kerf fitting. Suitable for external use and locations where moisture ingress may occur. Quick and easy installation.



▲ LAS1606

COMPRESSION SEALS



▲ LAS1606

SYSTEM SPECIFICATIONS

Characteristics

- ▶ Contributes towards sound, weather, draught, and light containment.

Location

- ▶ Head and jambs of single swing doors.

Use with

- ▶ Practically any threshold seal.

Min/max gap size

- ▶ 3mm/6mm.

Seal material

- ▶ Co-extruded elastomeric bulb with PVC spine.

Standard lengths

- ▶ 5m and 10m rolls.
- ▶ Subject to MOQs.

Fixing

- ▶ Interference fit into a kerf 2mm wide and minimum 6mm deep.

Colours

- ▶ White, grey, light brown or black.

COMPRESSION SEALS

S88

PEMKO BY LORIENT

The S88 is a versatile compression seal that is smoke and fire rated, listed for UL10B fire and UL10C positive pressure fire. The S88 gasket meets the criteria for Category G (edge sealing), Category H (fire and smoke), and Category J (fire) applications. This lightweight seal is self-adhesive making it easy to install, and it is available in a variety of colours.

Key benefits

- ▶ High temperature silicone
- ▶ Self-extinguishing and non-toxic
- ▶ Longest-lasting commercial grade door seal
- ▶ Unaffected by sunlight, ozone and ultraviolet rays
- ▶ Impervious to fungus and mildew
- ▶ Excellent compression; door latches easily
- ▶ Seal compresses to 1.5mm.

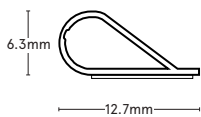

S88



S88

COMPRESSION SEALS

SYSTEM SPECIFICATIONS

Product testing

- ▶ **GreenGuard GOLD Certification:** Tested to UL2818 and achieved GOLD certification for low V.O.C. content – ulspot.com for certificate.
 - ▶ **Air Infiltration:** Tested to ASTM E-283-04 (2012) for low air leakage allowance; allows no more than 0.3 cfm per square foot at 1.57 psf (75 Pa).
 - ▶ **Acoustic:** Tested to ASTM E90 – 2009 in a single or in multiple sound seal configurations for sound attenuation in an opening.
 - ▶ **Smoke:** Tested to UL 1784 and meets the requirements of NFPA 105-2013 for smoke leakage in an opening; allows no more than 3.0 cfm per square foot at 0.10" water column (about 75 Pa).
 - ▶ **Fire:** Tested to UL10B Standard Fire Tests and UL10C Positive Pressure Fire Tests of Door Assemblies.
- ▶ **BHMA Certified:** Tested for performance with regards to the requirements in: ANSI/BHMA A156.22 – Door Gasketing and Edge Seal Systems.

Location

- ▶ Side of frame.

Min/max gap size

- ▶ 1.5mm/6mm.

Seal material

- ▶ Silicone.

Standard lengths

- ▶ 155.45m roll.
- ▶ Subject to MOQs.

Colours

- ▶ Black.

Fixing

- ▶ Self-adhesive tape.
- ▶ Note: contact surfaces must be clean, smooth and, if painted, well cured.
- ▶ Adhesive has a shelf life of 6 months.

Certification



DOOR BOTTOM SEALS



A range of versatile and hardwearing door bottom seals, that seal the gap between the bottom of the door and the floor.

They can be surface mounted or concealed in a rebated groove at the bottom of the door leaf. Use with a threshold plate for the optimum sealing solution.

DOOR BOTTOM SEALS

LAS3001 si

MORTISED

32dB

The LAS3001 si door bottom seal is a practical and efficient solution designed to enhance the acoustic containment of your door. Fitted with a slide-in gasket, this seal provides a dependable barrier that minimises sound transmission, helping to create a quieter and more comfortable space.

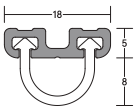

LAS3001 si



LAS3001 si (shown with LAS4001)

DOOR BOTTOM SEALS

SYSTEM SPECIFICATIONS

Test evidence

- ▶ Acoustic: BS EN ISO 10140-2: 2010. Rw 32dB.

Characteristics

- ▶ Contributes towards smoke, weather, draught, and light containment when fitted with a suitable threshold seal.

Location

- ▶ Single and double swing doors.

Use with

- ▶ Practically any threshold plate.

Min/max gap size

- ▶ 6mm/13mm.

Seal material

- ▶ Flexible silicone rubber.

Standard lengths

- ▶ 1m and 2.1m. Other lengths to special order.

Fixing

- ▶ Face-fixed, semi-rebated or fully rebated.
- ▶ Self-tapping wood screws are supplied (self-drilling and self-tapping screws for metal construction available on request).
- ▶ Fixing holes are pre-drilled. Once the aluminium carrier is fixed, the flexible silicone rubber gasket slides easily into place.
- ▶ Note: these seals cannot be adjusted once fitted.

Finish

- ▶ Silver anodised aluminium with grey silicone insert.

Certification



(R27972)

DOOR BOTTOM SEALS

LAS3002 si

MORTISED

31dB

The LAS3002 si door bottom seal is a practical and efficient solution designed to enhance the acoustic containment of your door. Equipped with two slide-in silicone blade seals, it forms a dependable barrier that minimises sound transmission creating a quieter and more comfortable space.



DOOR BOTTOM SEALS

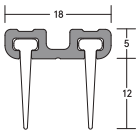

LAS3002 si



LAS3002 si (shown with LAS4001)

SYSTEM SPECIFICATIONS

Test evidence

- ▶ Acoustic: BS EN ISO 10140-2: 2010. Rw 31dB.

Characteristics

- ▶ Contributes towards smoke, weather, draught, and light containment when fitted with a suitable threshold seal.

Location

- ▶ Single and double swing doors.

Use with

- ▶ Practically any threshold plate.

Min/max gap size

- ▶ 10mm/17mm.

Seal material

- ▶ Flexible silicone rubber.

Standard lengths

- ▶ 1m and 2.1m. Other lengths to special order.

Fixing

- ▶ Face-fixed, semi-rebated or fully rebated.
- ▶ Self-tapping wood screws are supplied (self-drilling and self-tapping screws for metal construction available on request).
- ▶ Fixing holes are pre-drilled. Once the aluminium carrier is fixed, the flexible silicone rubber gasket slides easily into place.
- ▶ Note: these seals cannot be adjusted once fitted.

Finish

- ▶ Silver anodised aluminium with grey silicone insert.

Certification



(R27972)

LAS3003 si

MORTISED

The LAS3003 si door bottom seal is a practical and efficient solution designed to contribute to the sound containment of your door. Equipped with two durable silicone bulb seals, it forms a reliable barrier that helps reduce sound, smoke, draughts, and light—creating a quieter and more comfortable space.

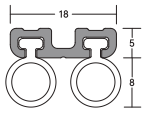

▲ LAS3003 si



▲ LAS3003 si (shown with LAS4001)



SYSTEM SPECIFICATIONS

Characteristics

- ▶ Contributes towards smoke, weather, draught, and light containment when fitted with a suitable threshold seal.

Location

- ▶ Single and double swing doors.

Use with

- ▶ Practically any threshold plate.

Min/max gap size

- ▶ 7mm/13mm.

Seal material

- ▶ Flexible silicone rubber.

- ▶ 1m and 2.1m. Other lengths to special order.

Fixing

- ▶ Face-fixed, semi-rebated or fully rebated.
- ▶ Self-tapping wood screws are supplied (self-drilling and self-tapping screws for metal construction available on request).
- ▶ Fixing holes are pre-drilled. Once the aluminium carrier is fixed, the flexible silicone rubber gasket slides easily into place.
- ▶ Note: these seals cannot be adjusted once fitted.

Finish

- ▶ Silver anodised aluminium with grey silicone insert.

Standard lengths

DOOR BOTTOM SEALS

LAS3004 si

FACE-FIXED

The LAS3004 si door bottom seal is a versatile, blade-type seal designed for straightforward, face-fixed installations, making it ideal for both new builds and retrofit applications. With its slimline aesthetic and flexible cover strip to neatly conceal fixings, the LAS3004 provides a discreet, professional finish. Its robust design accommodates larger threshold gap sizes and ensures long-lasting performance, and can contribute to the effective containment of smoke, draughts, light, and weather, creating a comfortable indoor environment.

DOOR BOTTOM SEALS

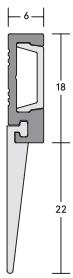

LAS3004 si



LAS3004 si (shown with LAS4010)

SYSTEM SPECIFICATIONS

Characteristics

- ▶ Contributes towards smoke, weather, draught, and light containment when fitted with a suitable threshold seal.

Location

- ▶ Single and double leaf doors.
- ▶ Up and over garage doors.
- ▶ Roller shutter doors.

Use with

- ▶ Practically any threshold plate.

Min/max gap size

- ▶ 10mm/22mm.

Seal material

- ▶ Flexible silicone rubber.

Standard lengths

- ▶ 1m and 2.1m. Other lengths to special order.

Fixing

- ▶ Self-tapping wood screws are supplied (self-drilling and self-tapping screws for metal construction available on request).
- ▶ Fixing holes are pre-drilled and slotted to allow the seals to be adjusted and positioned accurately.

Finishes

- ▶ Silver anodised aluminium with grey

cover strip and grey silicone rubber blade.

LAS3007 si

FACE-FIXED

The LAS3007 si door bottom seal is a multi-blade seal designed for easy installation without the need to remove the door, making it suitable for both new projects and retrofit applications. With concealed fixings and pre-drilled, slotted holes, the LAS3007 si allows for quick adjustments and compatibility with a choice of threshold plates. Its durable, anodised finish offers a sleek aesthetic, and its robust design can contribute to the effective containment of smoke, draughts, light, and weather, promoting a comfortable indoor environment.

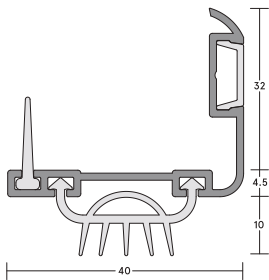

LAS3007 si



LAS3007 si (shown with LAS4010)



SYSTEM SPECIFICATIONS

Characteristics

- ▶ Contributes towards smoke, weather, draught, and light containment when fitted with a suitable threshold seal.

Location

- ▶ Single and double leaf doors.

Use with

- ▶ Practically any threshold plate, but ideally suited to LAS4015 si.

Min/max gap size

- ▶ 16mm/22mm.

Seal material

- ▶ Aluminium carrier with a flexible silicone rubber gasket.

Standard lengths

- ▶ 1m and 2.1m. Other lengths to special order.

Fixing

- ▶ Self-tapping wood screws are supplied (self-drilling and self-tapping screws for metal construction available on request).
- ▶ Fixing holes are pre-drilled and slotted to allow the seals to be adjusted and positioned accurately. A PVC cover strip to conceal fixings is supplied.

Finishes

- ▶ Silver anodised aluminium with grey cover strip and grey silicone rubber blade.
- ▶ Bronze anodised aluminium with black cover strip and black silicone rubber blade are subject to non-standard charges and additional lead times.

Certification



(R27972)

DOOR BOTTOM SEALS

LAS3008 si

FACE-FIXED

A multi-blade, door bottom seal combination consisting of the LAS3007 si door bottom seal and LAS4015 threshold plate. Durable, anodised aesthetic finish. It can be fitted without removing the door. Concealed fixings, pre-drilled and slotted holes on LAS3007 si for easy adjustment.

DOOR BOTTOM SEALS

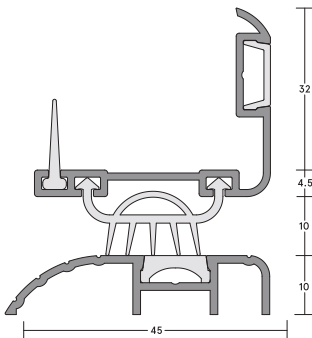

LAS3008 si



LAS3008 si

SYSTEM SPECIFICATIONS

Characteristics

- ▶ Contributes towards smoke, weather, draught, and light containment.

Location

- ▶ Single swing doors.

Min/max gap size

- ▶ 26mm/32mm.

Seal material

- ▶ LAS3007 si – Aluminium carrier with a flexible silicone rubber gasket.
- ▶ LAS4015 – Aluminium with PVC cover strip.

Standard lengths

- ▶ 1m and 2.1m. Other lengths to special order.

Fixing

- ▶ LAS3007 si – Self-tapping wood screws are supplied (self-drilling and self-tapping screws for metal construction available on request). Fixing holes are predrilled and slotted to allow the seals to be adjusted and positioned accurately.
- ▶ A PVC cover strip to conceal fixings is supplied.
- ▶ LAS4015 – Fixing screws are supplied. PVC cover strip to conceal fixings is supplied.

Finishes

- ▶ Silver anodised aluminium with grey cover strip and grey silicone rubber blade.
- ▶ Bronze anodised aluminium with black cover strip and black silicone rubber blade are subject to non-standard charges and additional lead times.

DOOR BOTTOM SEALS

LAS3009 si

MORTISED

The LAS3009 si door bottom seal is a practical and efficient solution designed to contribute to the sound and environmental containment of your door. Equipped with two durable silicone blade seals, it forms a reliable barrier that helps reduce sound, smoke, draughts, and light—creating a quieter and more comfortable space. Suitable for single and double swing doors, as well meeting stiles (one leaf only).

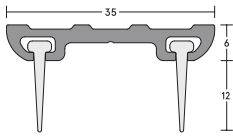

LAS3009 si



LAS3009 si (shown with LAS4002)

DOOR BOTTOM SEALS

SYSTEM SPECIFICATIONS

Characteristics

- ▶ Contributes towards smoke, weather, draught, and light containment when fitted with a suitable threshold seal.

Location

- ▶ Single and double swing doors.

Use with

- ▶ Practically any threshold plate.

Min/max gap size

- ▶ 16mm/22mm.

Seal material

- ▶ Flexible silicone rubber.

- ▶ 1m and 2.1m. Other lengths to special order.

Fixing

- ▶ Self-tapping wood screws are supplied (self-drilling and self-tapping screws for metal construction available on request).
- ▶ Fixing holes are pre-drilled. Once the aluminium carrier is fixed, the rubber gasket slides easily into place.
- ▶ Note: these seals cannot be adjusted once fitted.

- ▶ Silver anodised aluminium with grey silicone rubber blades.
- ▶ Bronze anodised aluminium with black silicone rubber blades are subject to non-standard charges and additional lead times.

Specification



Standard lengths

Finishes

THRESHOLD PLATES + RAMPS

Hardwearing aluminium threshold plates and ramps that are affixed to the sill beneath the door. Threshold plates provide a firm and effective sealing surface for threshold seals to rest against, while also covering the join between different flooring materials.

Threshold ramps feature a gentle sloping gradient to accommodate differences in floor heights.

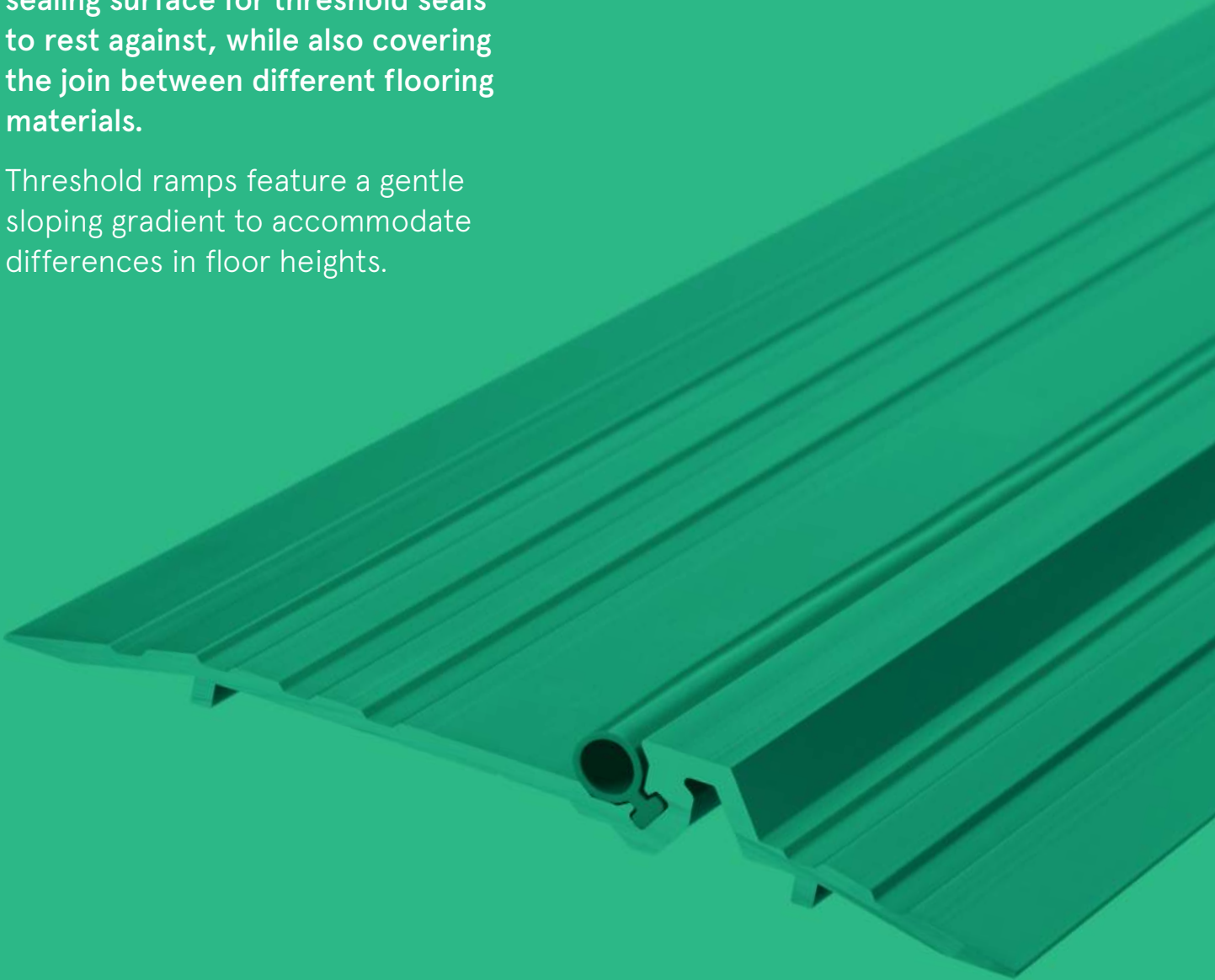

LAS4001 & LAS4002

Gently curved low-profile aluminium threshold plates. These plates can increase the effectiveness of threshold seals by creating a firmer gasket contact. Durable anodised aesthetic finish. Quick and easy installation.

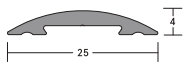

▲ LAS4001

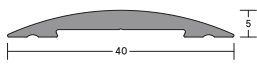

▲ LAS4002



▲ LAS4001

SYSTEM SPECIFICATIONS

Characteristics

- ▶ Contributes towards smoke, weather, draught, and light containment when fitted with a suitable threshold seal.
- ▶ Provides an even surface underneath the door; suitable for wheeled traffic.

Location

- ▶ Single and double swing doors.

Use with

- ▶ Practically any drop or door bottom seal.

Material

- ▶ Aluminium.

Standard lengths

- ▶ 1m and 2.1m. Other lengths to special order.

Fixing

- ▶ Fixing screws are supplied.

Finishes

- ▶ Silver anodised aluminium as standard.
- ▶ Bronze anodised aluminium and other powder-coated colour finishes are subject to non-standard charges and additional lead times.

Certification



(R27972)

THRESHOLD PLATES + RAMPS

LAS4010, LAS4011, LAS4012 & LAS4013

Low profile aluminium threshold plates, only 6mm high. Ideal for wheeled traffic. These plates can increase the effectiveness of threshold seals by creating a firmer gasket contact. Durable anodised aesthetic finish. Quick and easy installation.

THRESHOLD PLATES + RAMPS

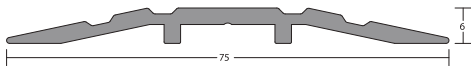

LAS4010

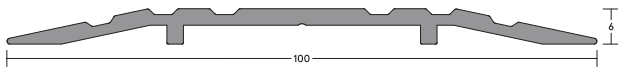

LAS4011

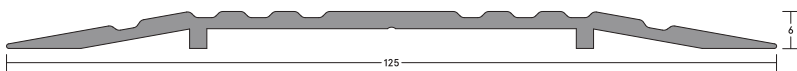

LAS4012

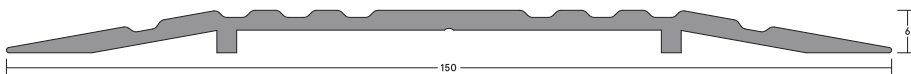

LAS4013



LAS4010

SYSTEM SPECIFICATIONS

Characteristics

- ▶ Contributes towards smoke, weather, draught, and light containment when fitted with a suitable threshold seal.
- ▶ Provides an even surface underneath the door; suitable for wheeled traffic.

Location

- ▶ Single and double swing doors.

Use with

- ▶ Practically any drop or door bottom seal.

Material

- ▶ Aluminium.

Standard lengths

- ▶ 1m and 2.1m. Other lengths to special order.

Fixing

- ▶ Fixing screws are supplied.

Finishes

- ▶ Silver anodised aluminium as standard.
- ▶ Bronze anodised aluminium and other powder-coated colour finishes are subject to non-standard charges and additional lead times.

Certification



(R27972)



NBS Source
PARTNER

LAS4014 si 42dB

The LAS4014 si threshold plate is a robust, aluminium threshold solution, suitable for use on fire-rated steel doorsets. Featuring a high-performance silicone compression seal, the LAS4014 helps prevent the penetration of rain, draughts, light, and noise, enhancing the comfort and protection of interior spaces. Its stepped design increases the effectiveness of threshold seals by creating a firmer gasket contact, while the durable anodised finish provides a sleek and resilient aesthetic.

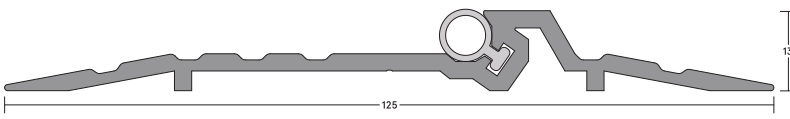

LAS4014 si



SYSTEM SPECIFICATIONS

Test evidence

- ▶ Smoke: BS 476-31.1: 1983 at ambient temperature.
- ▶ Acoustic: BS EN ISO 10140-2: 2010 (up to Rw 42dB).
- ▶ Durability: 100,000 cycles.

Characteristics

- ▶ Suitable for use of fire rated steel doorsets.
- ▶ Meets smoke requirement: BS 8214:2016.
- ▶ Contributes towards smoke, weather, draught, and light containment when fitted with a suitable threshold seal.
- ▶ Provides an even surface underneath the door; suitable for wheeled traffic.

Location

- ▶ Single and double leaf outward opening doors.

Use with

- ▶ Practically any drop or door bottom seal.

Material

- ▶ Aluminium and silicone gasket.

Standard lengths

- ▶ 1m and 2.1m. Other lengths to special order.

Fixing

- ▶ Fixing screws are supplied.

Finishes

- ▶ Silver anodised aluminium with grey silicone rubber gasket as standard.
- ▶ Bronze anodised aluminium with black silicone rubber gasket are subject to non-standard charges and additional lead times.

- ▶ Other powder-coated colour finishes (non-standard - charges and lead times apply).

Certification

certifire
(CF5179)



LAS4015

Aluminium threshold plate suitable for outward opening doors to prevent rain, draught and light. Can increase the effectiveness of threshold seals by creating a firmer gasket contact. Durable anodised aesthetic finish.

THRESHOLD PLATES + RAMPS

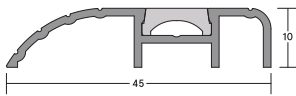

LAS4015



SYSTEM SPECIFICATIONS

Characteristics

- ▶ Contributes towards smoke, weather, draught, and light containment when fitted with a suitable threshold seal.
- ▶ Provides an even surface underneath the door; suitable for wheeled traffic.

Location

- ▶ Single and double leaf outward opening doors.

Use with

- ▶ Practically any drop or door bottom seal.

Material

- ▶ Aluminium and PVC cover strip.

Standard lengths

- ▶ 1m and 2.1m. Other lengths to special order.

Fixing

- ▶ Fixing screws are supplied.

Finishes

- ▶ Silver anodised aluminium as standard.
- ▶ Bronze anodised aluminium and other powder-coated colour finishes are subject to non-standard charges and additional lead times.

Certification



(R27972)



NBS Source
PARTNER

LAS4100

Durable, aluminium threshold plate, 10mm high. It can increase the effectiveness of threshold seals by creating a firmer gasket contact. Quick and easy installation.

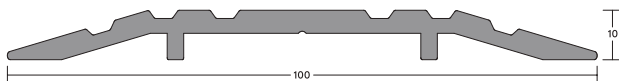

LAS4100



SYSTEM SPECIFICATIONS

Characteristics

- ▶ Protects against sound, smoke, weather, draught, light and insects when fitted with a suitable threshold seal.
- ▶ Provides an even surface underneath the door; suitable for wheeled traffic.

Location

- ▶ Single and double swing doors.

Use with

- ▶ Practically any drop or door bottom seal.

Material

- ▶ Aluminium.

Standard lengths

- ▶ 1m and 2.1m. Other lengths to special order.

Fixing

- ▶ Fixing screws are supplied.

Finishes

- ▶ Silver anodised aluminium as standard.
- ▶ Bronze anodised aluminium and other powder-coated colour finishes are subject to non-standard charges and additional lead times.

AAS4551

A 100mm wide threshold ramp for use in buildings where wheelchairs and trolleys are used, or to compensate for uneven floors. Reversible tread strips provide greater traction. Unique 'scoops' further enhance grip for foot or wheeled traffic.

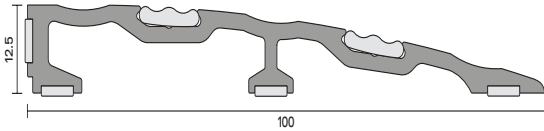

▲ AAS4551



▲ AAS4551

THRESHOLD PLATES + RAMPS

SYSTEM SPECIFICATIONS

Characteristics

- ▶ Contributes towards smoke, weather, draught, and light containment when fitted with a suitable threshold seal.
- ▶ Provides an even surface underneath the door; suitable for wheeled traffic.

Location

- ▶ Single and double swing doors.

Use with

- ▶ Practically any drop or door bottom seal.

Material

- ▶ Aluminium with two flexible thread strips.

Standard lengths

- ▶ 1m and 2.1m. Other lengths to special order.

Fixing

- ▶ Pre-drilled and countersunk
- ▶ Fixing screws are supplied.
- ▶ Tread strips supplied and push-fit into plate to conceal fixings

Finishes

- ▶ Silver anodised aluminium with grey tread strips as standard.
- ▶ Bronze anodised aluminium with black tread strips and other powder-coated colour finishes are subject to non-standard charges and additional lead times.

Certification



(R27972)

AAS4552

A 150mm wide threshold ramp for use in buildings where wheelchairs and trolleys are used, or to compensate for uneven floors. Reversible tread strips provide greater traction. Unique 'scoops' further enhance grip for foot or wheeled traffic.

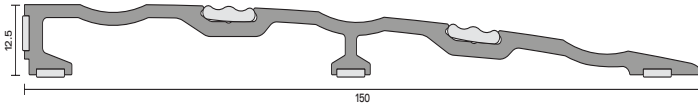

▲ AAS4552



▲ AAS4552

SYSTEM SPECIFICATIONS

Characteristics

- ▶ Contributes towards smoke, weather, draught, and light containment when fitted with a suitable threshold seal.
- ▶ Provides an even surface underneath the door; suitable for wheeled traffic.
- ▶ Provides an even surface underneath the door; suitable for wheeled traffic.

Location

- ▶ Single and double swing doors.

Use with

- ▶ Practically any drop or door bottom seal.

Material

- ▶ Aluminium with two flexible thread strips.

Standard lengths

- ▶ 1m and 2.1m. Other lengths to special order.

Fixing

- ▶ Pre-drilled and countersunk
- ▶ Fixing screws are supplied.
- ▶ Tread strips supplied and push-fit into plate to conceal fixings

Finishes

- ▶ Silver anodised aluminium with grey tread strips as standard.
- ▶ Bronze anodised aluminium with black tread strips and other powder-coated colour finishes are subject to non-standard charges and additional lead times.

Certification



(R27972)

THRESHOLD PLATES + RAMPS

AAS4553

A 150mm wide threshold ramp for use in buildings where wheelchairs and trolleys are used, or to compensate for uneven floors. Reversible tread strips provide greater traction. Unique 'scoops' further enhance grip for foot or wheeled traffic.

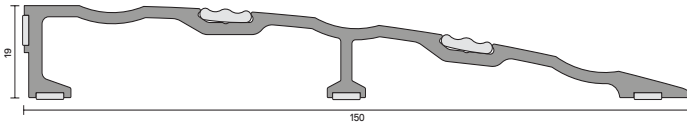

▲ AAS4553



▲ AAS4553

SYSTEM SPECIFICATIONS

Characteristics

- ▶ Contributes towards smoke, weather, draught, and light containment when fitted with a suitable threshold seal.
- ▶ Provides an even surface underneath the door; suitable for wheeled traffic.

Location

- ▶ Single and double swing doors.

Use with

- ▶ Practically any drop or door bottom seal.

Material

- ▶ Aluminium with two flexible thread strips.

Standard lengths

- ▶ 1m and 2.1m. Other lengths to special order.

Fixing

- ▶ Pre-drilled and countersunk
- ▶ Fixing screws are supplied.
- ▶ Tread strips supplied and push-fit into plate to conceal fixings

Finishes

- ▶ Silver anodised aluminium with grey tread strips as standard.
- ▶ Bronze anodised aluminium with black tread strips and other powder-coated colour finishes are subject to non-standard charges and additional lead times.

Certification



(R27972)

BRUSH SEALS



A series of hard-wearing sweep action brush seals suitable for numerous installations and door types; including single and double swing, revolving, sliding, up and over and roller shutter doors.

The independent filaments of the brush conform to irregular surfaces for a more complete seal.

BRUSH SEALS

LAS5010, LAS5015, LAS5020, LAS5025 & LAS5030

FACE-FIXED

Hard wearing brush seals, suitable for various installations and door types. Nylon brush seals with aluminium carriers. Flexible and durable. Quick and easy installation.

BRUSH SEALS

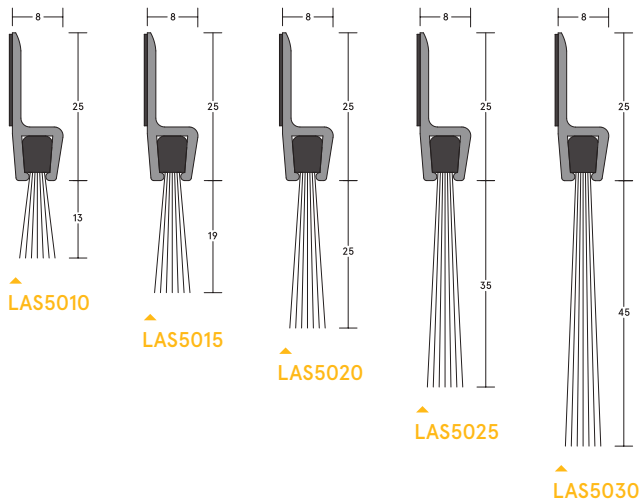

SYSTEM SPECIFICATIONS

Characteristics

- ▶ Contributes towards weather, draught, smoke, and light containment.

Location

- ▶ Head, jambs, threshold and meeting stiles of single and double swing doors and sliding doors.
- ▶ Head, jambs and threshold of revolving doors, up and over doors, and roller shutter doors.

Use with

- ▶ Any threshold plate.

Seal material

- ▶ Polypropylene brush filaments, UV stabilised.

Min/max gap size

- ▶ LAS5010: 10mm/13mm.
- ▶ LAS5015: 13mm/19mm.
- ▶ LAS5020: 19mm/25mm.
- ▶ LAS5025: 25mm/35mm.
- ▶ LAS5030: 35mm/45mm.

Standard lengths

- ▶ 1m and 2.1m. Other lengths to special order.

Fixing

- ▶ Heavy duty self-adhesive tape.
- ▶ Screw fixing recommended: screws not supplied.

Finishes

- ▶ Silver anodised aluminium with black brush filaments as standard.
- ▶ Bronze anodised aluminium with black brush filaments are subject to non-standard charges and additional lead times.

BRUSH SEALS

LAS5035, LAS5040, LAS5045, LAS5050 & LAS5055

FACE-FIXED

Hard wearing brush seals, suitable for numerous installations and door types. Nylon brush seals with aluminium carriers. Flexible and durable. Quick and easy installation.

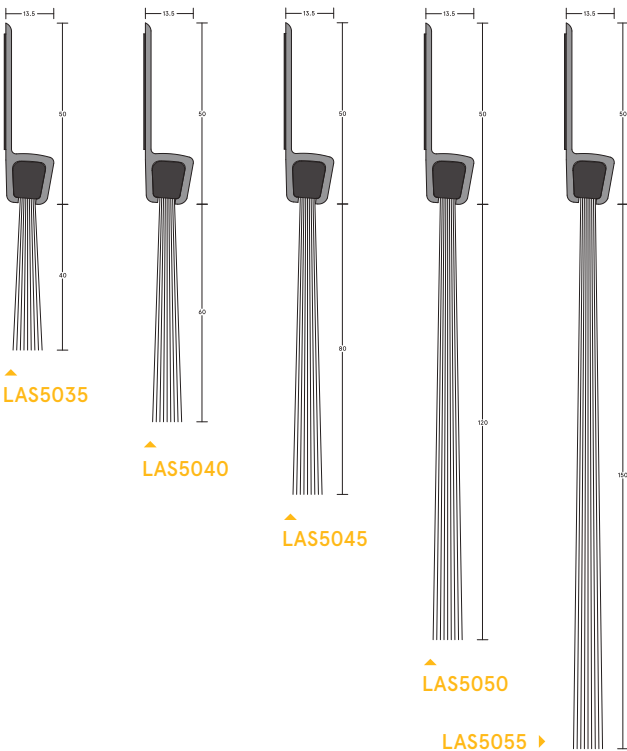

BRUSH SEALS

SYSTEM SPECIFICATIONS

Characteristics

- ▶ Contributes towards weather, draught, and light containment.

Location

- ▶ Head, jambs, threshold and meeting stiles of single and double swing doors, and sliding doors.
- ▶ Head, jambs and threshold of revolving doors, up and over doors, and roller shutter doors.

Use with

- ▶ Any threshold plate.

Seal material

- ▶ Polypropylene brush filaments, UV stabilised.

Min/max gap size

- ▶ LAS5035: 20mm/40mm.
- ▶ LAS5040: 40mm/60mm.
- ▶ LAS5045: 60mm/80mm.
- ▶ LAS5050: 80mm/120mm.
- ▶ LAS5055: 120mm/150mm.

Standard lengths

- ▶ 1m and 2.1m.
- Other lengths to special order.

Fixing

- ▶ Heavy duty self-adhesive tape.
- ▶ Screw fixing recommended: screws not supplied.

Finishes

- ▶ Silver anodised aluminium with black brush filaments as standard.
- ▶ Bronze anodised aluminium with black brush filaments are subject to non-standard charges and additional lead times.

BRUSH SEALS

LAS5060, LAS5065 & LAS5070

FACE-FIXED

Hard wearing brush seals, with 90° aluminium carriers. Flexible and durable. Quick and easy installation.

BRUSH SEALS

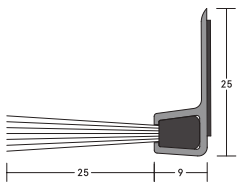

LAS5060

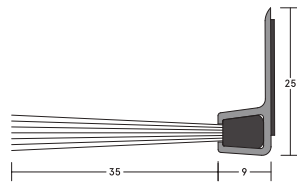

LAS5065

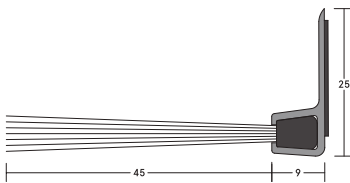

LAS5070



LAS5060

SYSTEM SPECIFICATIONS

Characteristics

- ▶ Contributes towards weather, draught, and light containment.

Location

- ▶ Sliding doors.

Min/max gap size

- ▶ LAS5060: 24mm/30mm.
- ▶ LAS5065: 32mm/40mm.
- ▶ LAS5070: 39mm/50mm.

Seal material

- ▶ Polypropylene brush filaments, UV stabilised.

Standard lengths

- ▶ 1m and 2.1m. Other lengths to special order.

Fixing

- ▶ Heavy duty self-adhesive tape.
- ▶ Screw fixing recommended: screws not supplied.

Finishes

- ▶ Silver anodised aluminium with black brush filaments as standard.
- ▶ Bronze anodised aluminium with black brush filaments are subject to non-standard charges and additional lead times.

BRUSH SEALS

LAS5075, LAS5080 & LAS5085

FACE-FIXED

Hard wearing, brush seals with 45° aluminium carriers. Flexible and durable. Quick and easy installation.

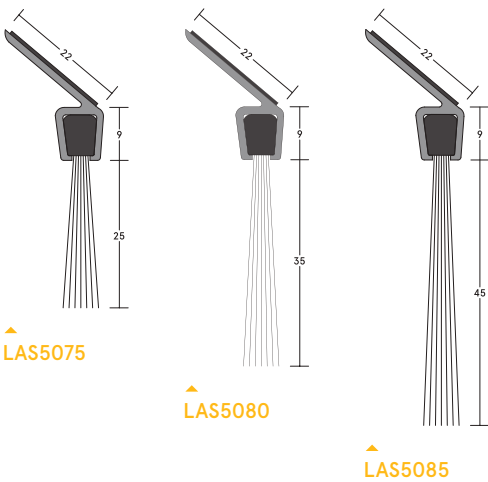

BRUSH SEALS

SYSTEM SPECIFICATIONS

Characteristics

- ▶ Contributes towards weather, draught, smoke and light containment.

Location

- ▶ A variety of industrial door applications requiring angled brushes.

Min/max gap size

- ▶ LAS5075: 19mm/25mm.
- ▶ LAS5080: 25mm/35mm.
- ▶ LAS5085: 35mm/45mm.

Seal material

- ▶ Polypropylene brush filaments, UV stabilised.

Standard lengths

- ▶ 1m and 2.1m. Other lengths to special order.

Fixing

- ▶ Heavy duty self-adhesive tape.
- ▶ Screw fixing recommended: screws not supplied.

Finishes

- ▶ Silver anodised aluminium with black brush filaments as standard.
- ▶ Bronze anodised aluminium with black brush filaments are subject to non-standard charges and additional lead times.



MAGNETIC SEALS

Magnetic seals for use on both steel and timber doors. These seals provide a tight seal for door jambs and may also be used as a stop.

These seals have sufficient magnetic strength that latches may not be required.

LAS6001

FACE-FIXED **40dB**

A refrigeration-type vinyl magnetic strip in anodised aluminium housing. The strip holds the door closed so latches are not always required. Concealed fixings, pre-drilled and slotted holes for easy adjustment. Easily installed without removing the door and it can be used as a stop. Option to be supplied with magnetic keeper strip.

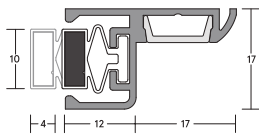

LAS6001



LAS6011



SYSTEM SPECIFICATIONS

Test evidence

- ▶ Acoustic: BS EN ISO 10140-2: 2010 (up to Rw 40dB).

Characteristics

- ▶ Contributes towards sound, smoke weather, draught, and light containment.

Location

- ▶ Head and jambs of single swing steel clad doors and timber doors (use with LAS6011).

Seal material

- ▶ LAS6001 – flexible insert with magnetic core.
- ▶ LAS6011 – PVC sleeve with magnetic insert.

Standard lengths

- ▶ 1m and 2.1m. Other lengths to special order.
- ▶ Subject to MOQs.

Fixing

- ▶ Self-tapping wood screws are supplied (self-drilling and self-tapping screws for metal construction available on request).
- ▶ Fixing holes are pre-drilled and slotted to allow the seals to be adjusted and positioned accurately. A PVC cover strip to conceal fixings is supplied.
- ▶ LAS6011 has an aggressive self-adhesive backing for fixing into a groove on timber doors.
- ▶ Note: order LAS6011 magnetic keeper strip for use with timber doors. Supplied with self-adhesive backing as standard.

Finishes

- ▶ LAS6001 – silver anodised aluminium with grey insert as standard.
- ▶ LAS6011 – white, black, grey, light brown, dark brown PVC sleeve. Other colours to special order subject to MOQs.

MAGNETIC SEALS

LAS6002

MORTISED

A magnetic seal that has sufficient magnetic strength to hold the door closed so latches are not always required.

MAGNETIC SEALS

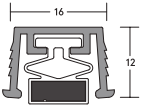

LAS6002



SYSTEM SPECIFICATIONS

Characteristics

- ▶ Contributes towards sound, smoke weather, draught, and light containment.

Location

- ▶ Rebated meeting stiles of double leaf doors.
- ▶ Sliding doors.

Seal material

- ▶ Grey flexible insert with black magnetic core.

Standard lengths

- ▶ 2.1m. Other lengths to special order.

Fixing

- ▶ The aluminium profile is toothed to lock into a 16mm x 12mm groove.
- ▶ The magnetic seals are also 'locked' into prevent creeping.

Finish

- ▶ Silver anodised aluminium with grey insert as standard. Black insert available to special order.
- ▶ Note: not suitable where centre latching is required.

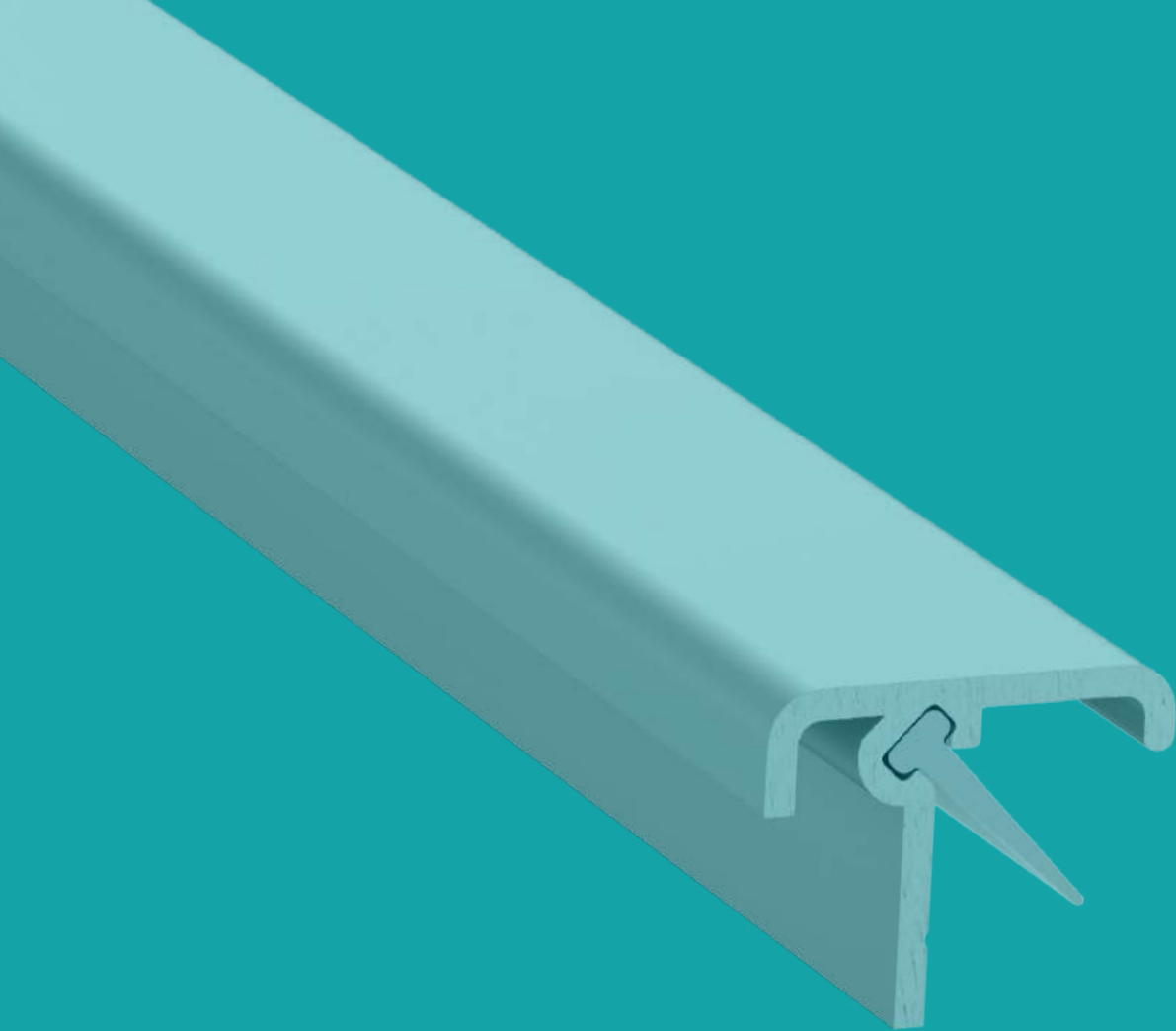

MEETING STILE SEALS

Meeting stile seals for use on both plain or rebated doors. These seals provide a seal between single swing, double doors.

Designed to protect against smoke, sound, light and draught containment.

MEETING STILE SEAL

LAS7006 si

FACE-FIXED

A high-performance seal designed for use on plain or rebated meeting stiles. With proven medium-temperature smoke containment capability, it also makes a positive contribution to light, sound, and draught containment. The leg can be cut out to accommodate locks and latches.

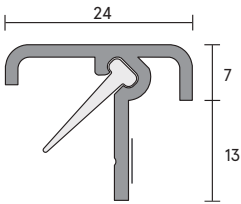

▲ LAS7006 si



SYSTEM SPECIFICATIONS

Test evidence

- ▶ Smoke: BS EN 1634-3:2004 at ambient and medium temperature; effective smoke seal up to 200°C.

Characteristics

- ▶ Contributes towards sound, smoke weather, draught, and light containment.

Location

- ▶ Meeting stiles of single swing doors.
- ▶ Double doors – where only one door leaf is in use or a door selector is fitted.

Use with

- ▶ Practically any perimeter seal.

Seal material

- ▶ Aluminium carrier with flexible silicone blade.

Standard length

- ▶ 2.1m.

Fixing

- ▶ Secure with heavy duty self-adhesive tape.
- ▶ Screw into place (fixings supplied).
- ▶ Note: A door selector should be considered unless one leaf is intended to be fixed.

Finishes

- ▶ Silver anodised aluminium with grey silicone rubber gasket as standard.
- ▶ Other finishes available to special order (non-standard – charges and lead times apply).

MEETING STILE SEAL

ASS7506

FACE-FIXED

A robust seal designed for use on plain or rebated meeting stiles. With proven acoustic performance it is also suitable for smoke, light, and draught containment. The leg can be cut out to make way for locks and latches.

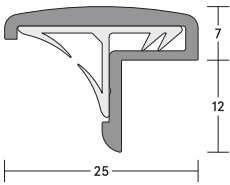

▲
AAS7506

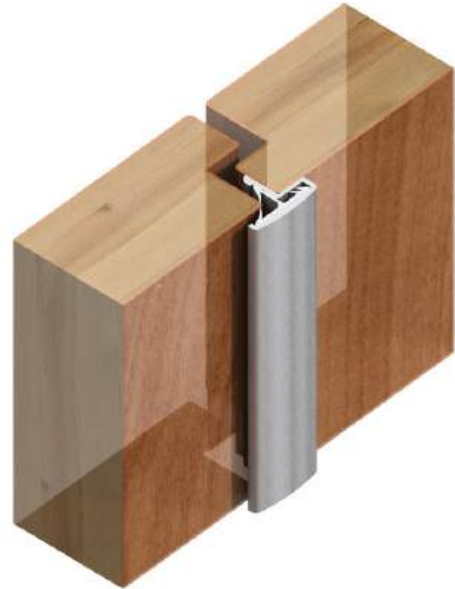

▲
AAS7506

SYSTEM SPECIFICATIONS

Test evidence

- ▶ Acoustic: BS EN ISO 10140-2: 2010.
- ▶ Weighted Sound Reduction Index: 33dB (AAS7506 & AAS8501 on a standard architectural door).

Characteristics

- ▶ Contributes towards sound, smoke weather, draught, and light containment.

Location

- ▶ Meeting stiles of single swing doors.
- ▶ Double doors – where only one door leaf is in use or a door selector is fitted.

Use with

- ▶ Practically any perimeter seal.

Seal material

- ▶ Anodised aluminium carrier with co-extruded elastomeric insert with flexible curved fins.

Architectural Seals

Standard length

- ▶ 1m & 2.1m.

Fixing

- ▶ Fixing holes pre-punched and countersunk.
- ▶ Wood screws supplied – please request self-tappers.
- ▶ Using self-adhesive tape to position aluminium carrier while fixing, push-fit Batwing® seal into place.
- ▶ Note: A door selector should be considered unless one leaf is intended to be fixed.

Finishes

- ▶ Silver anodised aluminium with grey insert as standard. Other finishes available to special order (non-standard – charges and lead times apply).
- ▶ Black, white, dark brown, light brown, clear, red, silver and cream Batwing® inserts are subject to MOQs.

PERIMETER SEALS

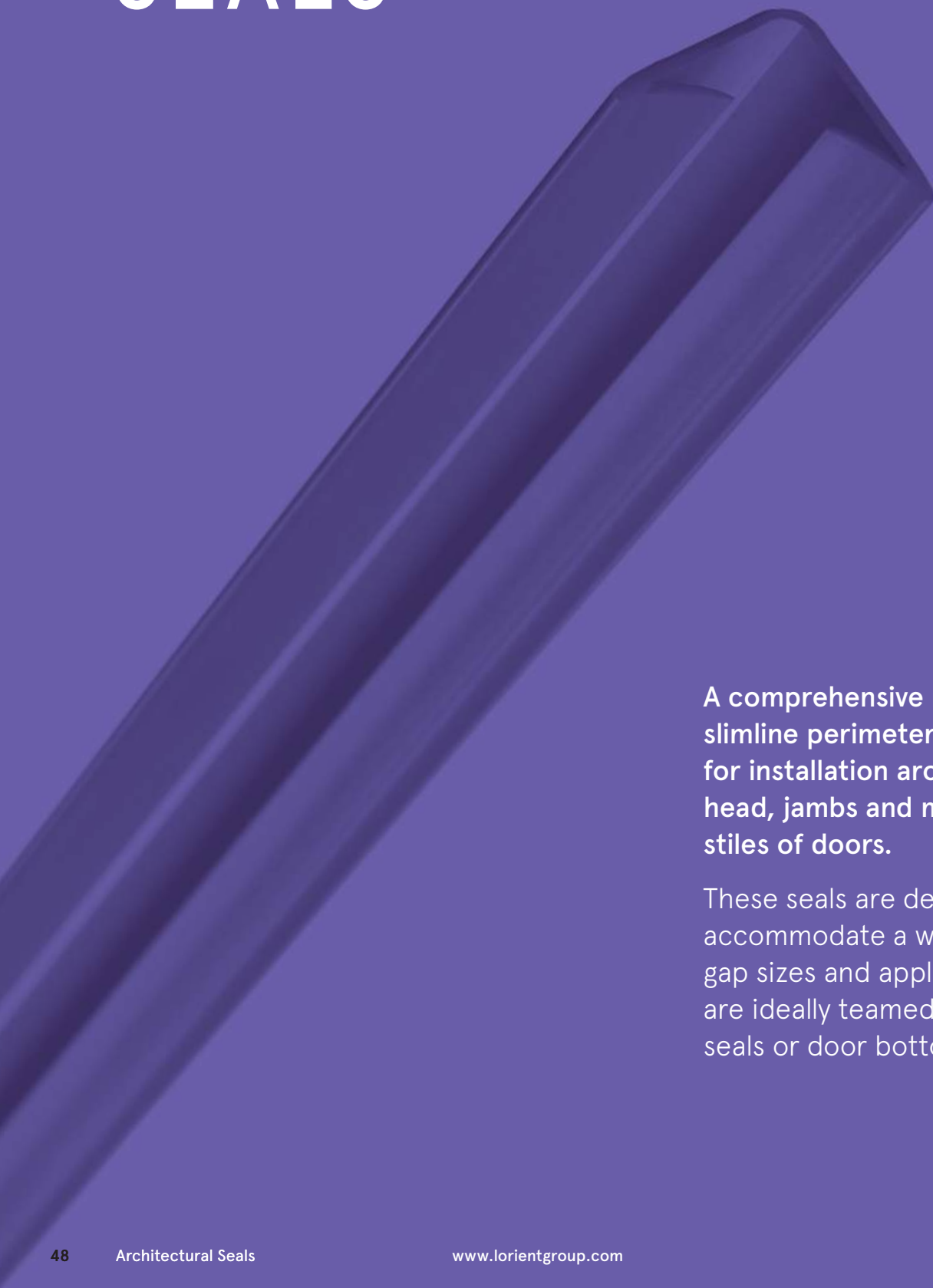

A comprehensive range of slimline perimeter seals for installation around the head, jambs and meeting stiles of doors.

These seals are designed to accommodate a wide range of gap sizes and applications, and are ideally teamed with drop seals or door bottom seals.

LAS1206 Single Batwing®

FACE-FIXED

The LAS1206 single Batwing® is a smoke and acoustic perimeter seal. Its 10mm high, single fin design creates a tight seal while minimising the force required to open and close the door. Made from a flexible elastomeric material, the fin springs back into shape after every use, ensuring long-lasting performance. Easy to install with minimal disruption, the LAS1206 is suitable for both single and double leaf doors on the head and jambs.

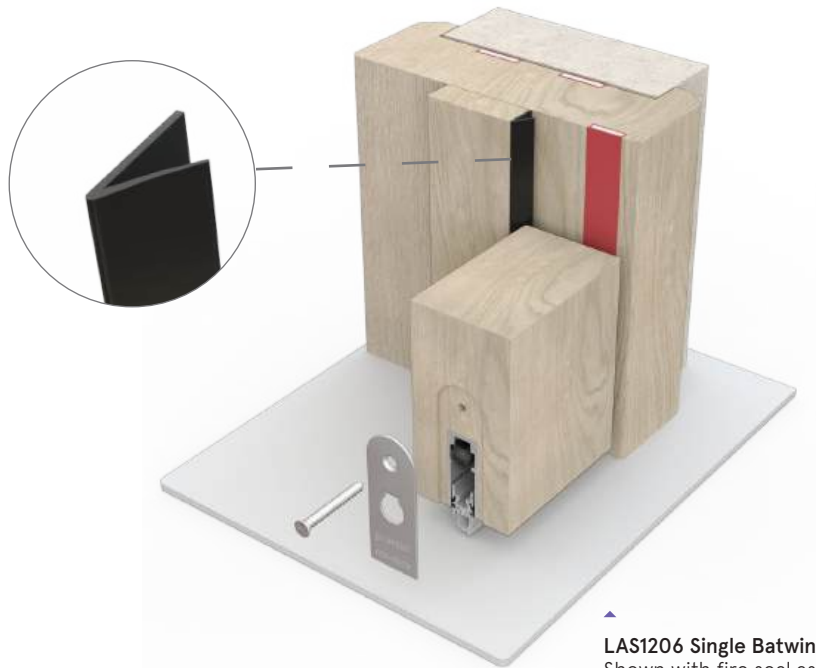

▲
LAS1206 Single Batwing®
Shown with fire seal as
referenced in CNA/F14171
(also shown with LAS8001 si)

SYSTEM SPECIFICATIONS

Test evidence

- ▶ Smoke: BS 476-31.1: 1983 at ambient temperature.
- ▶ Acoustic: BS EN ISO 10140-2: 2010 (up to Rw 34dB).
- ▶ Durability: 100,000 cycles.

Characteristics

- ▶ Contributes towards sound, smoke, draught, and light containment.

Location

- ▶ Head and jambs of single and double leaf doors,

Use with

- ▶ Any fire seals or architectural seals.

Min/max gap size

- ▶ 3mm/4mm.

Seal material

- ▶ Co-extruded rigid back PVC with flexible fins.

Standard lengths

- ▶ 1m and 2.1m.
- ▶ Other lengths to special order.

Fixing

- ▶ Heavy duty self-adhesive backing tape.

Colours

- ▶ Black, white, dark brown, light brown and grey as standard.
- ▶ Silver, cream, red and clear are subject to MOQs.
- ▶ Note: clear Batwing® will not prevent light penetration.

Certification



(R27972)

LAS1007 Single Batwing®

FACE-FIXED

The LAS1007 single Batwing® is a smoke and acoustic perimeter seal for fire-rated steel-based door assemblies / doorsets. Its 14mm high, single fin design creates a tight seal while minimising the force required to open and close the door. Made from a flexible elastomeric material, the fin springs back into shape after every use, ensuring long-lasting performance. Easy to install with minimal disruption, the LAS1007 is suitable for both single and double leaf doors on the head and jambs.

PERIMETER SEALS



LAS1007
Single
Batwing®

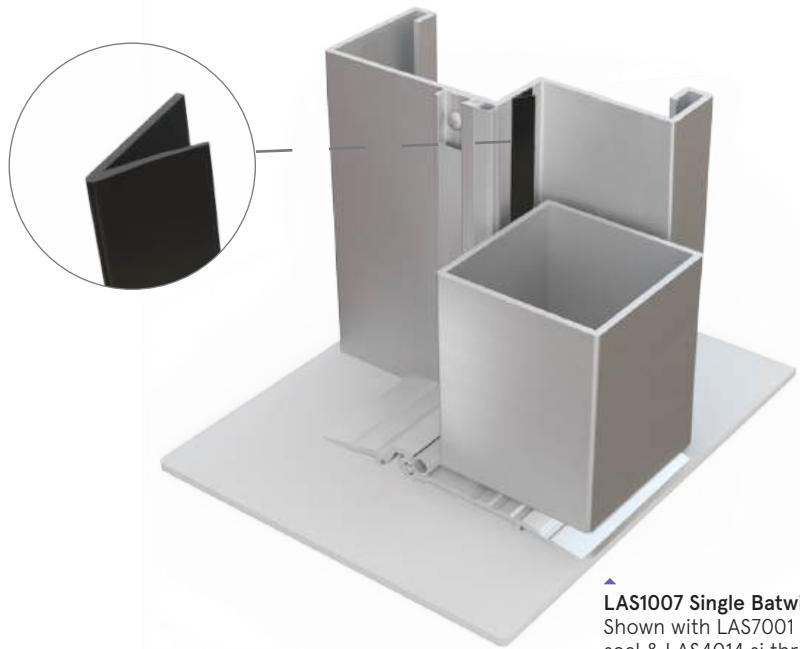

LAS1007 Single Batwing®
Shown with LAS7001 si perimeter
seal & LAS4014 si threshold plate

SYSTEM SPECIFICATIONS

Test evidence

- ▶ Smoke: BS 476-31.1: 1983 at ambient temperature; BS EN 1634-3:2004 at ambient temperature.
- ▶ Acoustic: BS EN ISO 10140-2: 2010 (up to Rw 34dB).
- ▶ Durability: 100,000 cycles.

Characteristics

- ▶ Suitable for use on steel based door assemblies.
- ▶ Contributes towards sound, smoke, draught, and light containment.

Location

- ▶ Head and jambs of single and double leaf doors,

Use with

- ▶ Any fire seals or architectural seals.

Min/max gap size

- ▶ 3mm/4mm.

Seal material

- ▶ Co-extruded rigid back PVC with flexible fins.

Standard lengths

- ▶ 1m and 2.1m.
- ▶ Other lengths to special order.

Fixing

- ▶ Heavy duty self-adhesive backing tape.

Colours

- ▶ Black, white, dark brown, light brown and grey as standard.
- ▶ Silver, cream, red and clear are subject to MOQs.
- ▶ Note: clear Batwing® will not prevent light penetration.

Certification

certifire
(CF5179)



LAS1010, LAS1212, LAS1015 Batwing®

FACE-FIXED

The LAS1010, LAS1212 & LAS1015 Batwing® smoke and acoustic seals are designed for easy installation with a simple peel and stick feature. The double fin design provides a reliable barrier against smoke and sound while minimising resistance when opening and closing the door.

Made from a flexible elastomeric material, the Batwing® seals boasts long-lasting performance as the fins spring back to their original shape after each use. Suitable for both single and double leaf doors on the head and jambs, this Batwing® seal installs with minimal disruption, offering a simple solution for smoke and acoustic containment.

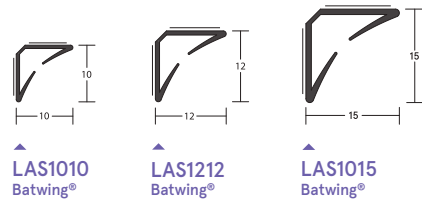

PERIMETER SEALS

SYSTEM SPECIFICATIONS

Test evidence

- ▶ Smoke: BS 476-31.1: 1983 at ambient temperature; BS EN 1634-3:2004 at ambient and medium temperature (LAS1212); effective smoke seal up to 200°C.
- ▶ Acoustic: BS EN ISO 10140-2: 2010 (up to Rw 44dB).
- ▶ Durability: minimum of 100,000 cycles.

Characteristics

- ▶ Contributes towards sound, smoke, draught, and light containment.

Features

- ▶ Seal surface and fins contain anti-microbial additives.

Location

- ▶ Head and jambs of single and double leaf doors.

Use with

- ▶ Any fire seals or architectural seals.

Min/max gap size

- ▶ 3mm/4mm.

Seal material

- ▶ Co-extruded rigid back PVC with flexible fins.

Standard lengths

- ▶ 1m and 2.1m.
- ▶ Other lengths to special order.

Fixing

- ▶ Heavy duty self-adhesive backing tape.

Colours

- ▶ Black, white, dark brown, light brown and grey as standard.
- ▶ Silver, cream, red and clear are subject to MOQs.
- ▶ Note: clear Batwing® will not prevent light penetration.

Certification



(R27972)



LAS1212



LAS1206K Batwing® on-a-stick

FACE-FIXED **32dB**

The LAS1206K Single Batwing®-on-a-stick is a smoke and acoustic seal designed for easy installation with its innovative kerf fixing feature. The single fin design provides a reliable barrier against smoke and sound while minimising resistance when opening and closing the door. Made from a flexible elastomeric material, the LAS1206K boasts long-lasting performance as the fin springs back to its original shape after each use.

PERIMETER SEALS



LAS1206K
Batwing®
on-a-stick



LAS1206K Batwing®

SYSTEM SPECIFICATIONS

Test evidence

- ▶ Smoke: BS 476-31.1: 1983 at ambient temperature.
- ▶ Acoustic: BS EN ISO 10140-2: 2010 (up to Rw 37dB).
- ▶ Durability: minimum of 100,000 cycles.

Characteristics

- ▶ Contributes towards sound, smoke, draught, and light containment.

Location

- ▶ Head and jambs of single and double leaf doors.

Use with

- ▶ Practically any drop seal.

Min/max gap size

- ▶ 3mm/4mm.

Seal material

- ▶ Co-extruded rigid back PVC with flexible fins.

Standard lengths

- ▶ 1m and 2.1m.
- ▶ Other lengths to special order.

Fixing

- ▶ Route a groove, and push-fit into place.
- ▶ Groove size is 11mm x 3mm – suitable for internal or external use.

Colours

- ▶ Black, white, dark brown, light brown and grey as standard.
- ▶ Silver, cream, red and clear are subject to MOQs.
- ▶ Note: clear Batwing® will not prevent light penetration.

Certifications



(R27972)

LAS1212K Batwing® on-a-stick

KERF-FIT

37dB

The LAS1212K Batwing®-on-a-stick is a smoke and acoustic seal designed for easy installation with its innovative kerf fixing feature. The 12mm profile, with a double fin design provides a reliable barrier against smoke and sound while minimising resistance when opening and closing the door.

Made from a flexible elastomeric material, the LAS1212K boasts long-lasting performance as the fins spring back to their original shape after each use. Suitable for both single and double leaf doors on the head and jambs, this Batwing® seal installs with minimal disruption, offering a simple solution for smoke and acoustic containment.

PERIMETER SEALS

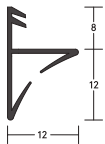

LAS1212K
Batwing®
on-a-stick



LAS1212K Batwing®

PERIMETER SEALS

SYSTEM SPECIFICATIONS

Test evidence

- ▶ Smoke: BS 476-31.1: 1983 at ambient temperature.
- ▶ Acoustic: BS EN ISO 10140-2: 2010 (up to Rw 37dB).
- ▶ Durability: minimum of 100,000 cycles.

Characteristics

- ▶ Contributes towards sound, smoke, draught, and light containment.

Location

- ▶ Head and jambs of single and double leaf doors.

Use with

- ▶ Practically any drop seal.

Min/max gap size

- ▶ 3mm/4mm.

Seal material

- ▶ Co-extruded rigid back PVC with flexible fins.

Standard lengths

- ▶ 1m and 2.1m.
- ▶ Other lengths to special order.

Fixing

- ▶ Route a groove, and push-fit into place.
- ▶ Groove size is 9mm x 3mm – suitable for internal or external use.

Colours

- ▶ Black, white, dark brown, light brown and grey as standard.
- ▶ Silver, cream, red and clear are subject to MOQs.
- ▶ Note: clear Batwing® will not prevent light penetration.

Certifications

certifire
(CF5179)



LAS1011 & LAS1016 Firtree®

KERF-FIT

Highly effective acoustic seals, which also provide additional cold smoke protection around the perimeter of fire rated doors. Flexible and durable. They can be fitted with minimal disruption to the door assembly.

PERIMETER SEALS

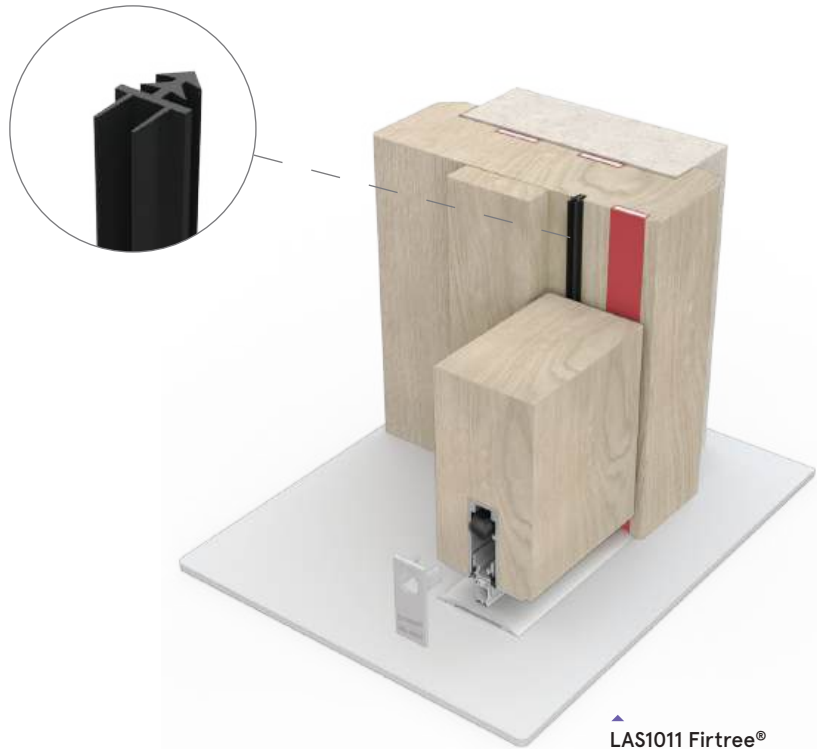
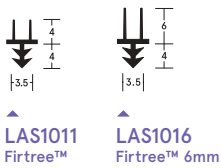

LAS1011 Firtree®
 Shown with fire seal as referenced in CNA/F14171 (shown with LAS8005 si + LAS4002)

SYSTEM SPECIFICATIONS

Test evidence

- ▶ Smoke: BS 476-31.1: 1983 at ambient temperature.
- ▶ Acoustic: BS EN ISO 10140-2: 2010 (up to Rw 40dB).
- ▶ Durability: minimum of 100,000 cycles.

Characteristics

- ▶ Contributes towards sound, smoke, draught, and light containment.

Location

- ▶ Head and jambs of single and double leaf doors. May also be used at the threshold when combined with a threshold plate.

Use with

- ▶ Any fire seals or architectural seals.

Min/max gap size

- ▶ 3mm/4mm (LAS1011).
- ▶ 4mm/6mm (LAS1016).

Seal material

- ▶ Co-extruded rigid back PVC with flexible fins.

Standard lengths

- ▶ 1m and 2.1m.
- ▶ Other lengths to special order.

Fixing

- ▶ Groove size is 3mm x 4mm.

Colours

- ▶ Black or white as standard.
- ▶ Dark brown and light brown are subject to MOQs.

Certification



LAS1011



(R27972)
LAS1011

certifire

(CF5179)
LAS1011

LAS7001 si

FACE-FIXED **33dB**

Slimline, aluminium, perimeter seal featuring a silicone gasket ideal for smoke and acoustic containment. Designed to be fitted to existing door stops. A neat cover plate conceals fixing screws. Easily installed without removing the door.

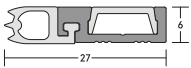

▲ LAS7001 si



▲ LAS7001 si

SYSTEM SPECIFICATIONS

Test evidence

- ▶ Smoke: BS EN 1634-3:2004 at ambient and medium temperature; effective smoke seal up to 200°C.
- ▶ Acoustic: BS EN ISO 10140-2: 2010 si (up to Rw 33dB).
- ▶ Durability: 100,000 cycles.

Characteristics

- ▶ Suitable for use on timber & steel based door assemblies.
- ▶ Contributes towards sound, smoke, draught, weather, and light containment.

Location

- ▶ Head and jambs of single swing doors.

Use with

- ▶ Practically any threshold seal.

Seal material

- ▶ Flexible silicone rubber.

Standard lengths

- ▶ 1m and 2.1m. Single doorset pack consisting of 1 x 1m and 2 x 2.1m. Other lengths to special order.

Fixing

- ▶ Self-tapping wood screws are supplied (self-drilling and self-tapping screws for metal construction available on request).
- ▶ Fixing holes are pre-drilled and slotted to allow the seals to be adjusted and positioned accurately. A PVC cover strip to conceal fixings is supplied.

Finishes

- ▶ Silver anodised aluminium with grey cover strip and grey silicone rubber gasket as standard.
- ▶ Bronze anodised aluminium with black cover strip and black silicone rubber gasket or other powder-coated colour finishes are subject to non-standard charges and additional lead times.

Certification

certifire
(CF5179)



PERIMETER SEALS

LAS7002 si

FACE-FIXED **34dB**

Slimline, aluminium, perimeter seal featuring a silicone gasket ideal for smoke and acoustic containment. Designed to be fitted to existing door stops. A neat cover plate conceals fixing screws. Easily installed without removing the door.

PERIMETER SEALS

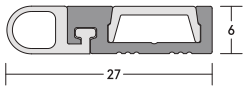

LAS7002 si



LAS7002 si

SYSTEM SPECIFICATIONS

Test evidence

- ▶ Smoke: BS 476-31.1: 1983 at ambient temperature.
- ▶ Acoustic: BS EN ISO 10140-2: 2010. si (up to R_w 34dB).
- ▶ Durability: 100,000 cycles.

Characteristics

- ▶ Contributes towards sound, smoke, draught, weather, and light containment.

Location

- ▶ Head and jambs of single swing doors.

Use with

- ▶ Practically any threshold seal.

Seal material

- ▶ Flexible silicone rubber.

Standard lengths

- ▶ 1m and 2.1m. Single doorset pack consisting of 1 x 1m and 2 x 2.1m. Other lengths to special order.

Fixing

- ▶ Self-tapping wood screws are supplied (self-drilling and self-tapping screws for metal construction available on request).
- ▶ Fixing holes are pre-drilled and slotted to allow the seals to be adjusted and positioned accurately. A PVC cover strip to conceal fixings is supplied.

Finishes

- ▶ Silver anodised aluminium with grey cover strip and grey silicone rubber gasket as standard.
- ▶ Bronze anodised aluminium with black cover strip and black silicone rubber gasket or other powder-coated colour finishes are subject to non-standard charges and additional lead times.

Certification

certifire
(CF5179)



LAS7003 si

FACE-FIXED **33dB**

Slimline, perimeter seal designed to be compressed between the door and the stop when the door is closed, compensating for warped or unevenly hung doors. Designed to be fitted to existing door stops. A neat cover plate conceals fixing screws. Easily installed without removing the door.

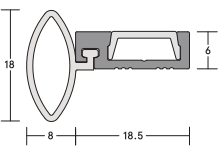

▲ LAS7003 si



▲ LAS7003 si

PERIMETER SEALS

SYSTEM SPECIFICATIONS

Test evidence

- ▶ Smoke: BS 476-31.1: 1983.
- ▶ Acoustic: BS EN ISO 10140-2:2010 (up to Rw 33dB).
- ▶ Durability: 100,000 cycles.

Characteristics

- ▶ Contributes towards sound, smoke, draught, weather, and light containment.

Location

- ▶ Head and jambs of single swing doors.

Use with

- ▶ Practically any threshold seal.

Seal material

- ▶ Flexible silicone rubber.

Standard lengths

- ▶ 1m and 2.1m. Single doorset pack consisting of 1 x 1m and 2 x 2.1m. Other lengths to special order.

Fixing

- ▶ Self-tapping wood screws are supplied (self-drilling and self-tapping screws for metal construction available on request)
- ▶ Fixing holes are pre-drilled and slotted to allow the seals to be adjusted and positioned accurately. A PVC cover strip to conceal fixings is supplied.

Finishes

- ▶ Silver anodised aluminium with grey cover strip and grey silicone rubber gasket as standard.
- ▶ Bronze anodised aluminium with black cover strip and black silicone rubber gasket or other powder-coated colour finishes are subject to non-standard charges and additional lead times.

Certification

certifire
(CF5179)

PERIMETER SEALS

LAS7004 si

FACE-FIXED **34dB**

Slimline, perimeter seal designed for timber doors with plain or rebated meeting stiles and where a centre latch is required. The leg of this seal can be cut out to accommodate the latch plate. Easily installed without removing the door.

PERIMETER SEALS

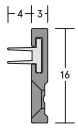

▲ LAS7004 si
4mm

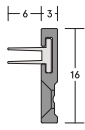

▲ LAS7004 si
6mm



▲ LAS7004 si

SYSTEM SPECIFICATIONS

Test evidence

- ▶ Acoustic: BS EN ISO 10140-2:2010 (up to Rw 34dB).
- ▶ Note: two rows of twin elastomeric fins will provide optimum acoustic performance.

Characteristics

- ▶ Contributes towards sound, smoke, draught, weather, and light containment.

Location

- ▶ Meeting stiles of single and double swing doors.
- ▶ Sliding and revolving doors.

Use with

- ▶ Practically any threshold seal.

Seal material

- ▶ Choose from: (i) 4mm projection twin elastomeric fins (ii) 6mm projection twin elastomeric fins.

Standard lengths

- ▶ 1m and 2.1m. Other lengths to special order.

Fixing

- ▶ Wood screws are supplied (self-tapping screws for metal frames are available on request).
- ▶ Fixing holes are predrilled and countersunk.

Finishes

- ▶ Silver anodised aluminium with grey cover strip and grey silicone rubber gasket as standard.
- ▶ Bronze anodised aluminium with black cover strip and black silicone rubber gasket or other powder-coated colour finishes are subject to non-standard charges and additional lead times.

LAS7005 si

FACE-FIXED **31dB**

A neat, aesthetically designed, compact perimeter seal with proven effective acoustic performance. Decorative cover strip conceals fixings. This seal can be used to replace the stop on steel or timber framed doors. To avoid excessive impact on the seal we recommend using a door closer to aid closing control.

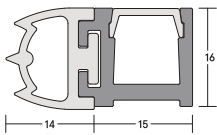

▲ LAS7005 si



▲ LAS7005 si



SYSTEM SPECIFICATIONS

Test evidence

- ▶ Acoustic: BS EN ISO 10140-2:2010 (up to Rw 31dB).

Characteristics

- ▶ Contributes towards sound, smoke, draught, weather, and light containment.

Location

- ▶ Head and jambs of single swing doors.

Use with

- ▶ Practically any threshold seal.

Seal material

- ▶ Flexible silicone rubber.

Standard lengths

- ▶ 1m and 2.1m. Single doorset pack consisting of 1 x 1m and 2 x 2.1m.
- ▶ Other lengths to special order.

Fixing

- ▶ Self-tapping wood screws are supplied (self-drilling and self-tapping screws for metal construction available on request)
- ▶ Fixing holes are pre-drilled and slotted to allow the seals to be adjusted and positioned accurately. A PVC cover strip to conceal fixings is supplied.

Finishes

- ▶ Silver anodised aluminium with grey cover strip and grey silicone rubber gasket as standard.
- ▶ Bronze anodised aluminium with black cover strip and black silicone rubber gasket or other powder-coated colour finishes are subject to non-standard charges and additional lead times.

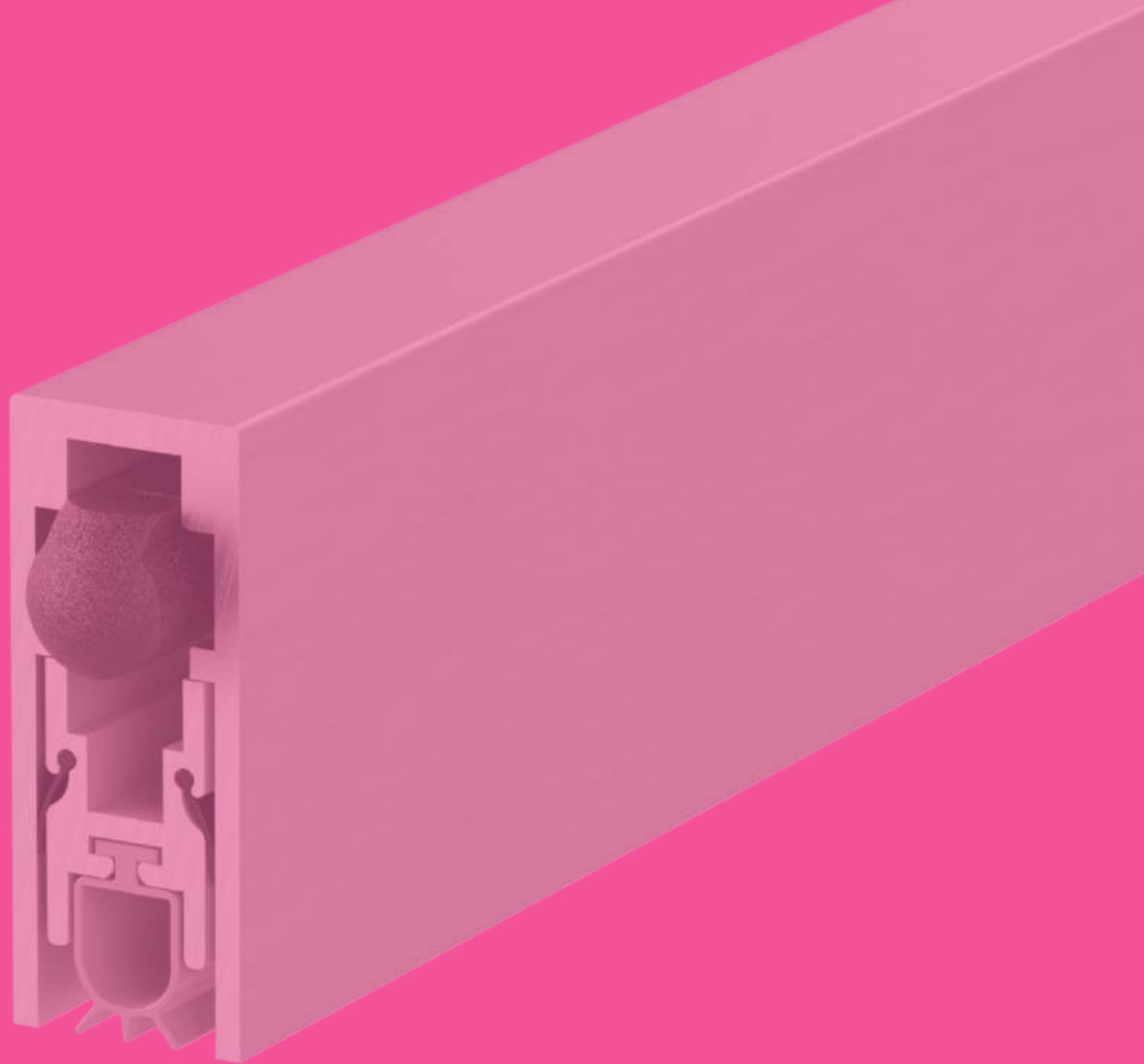

DROP SEALS

A range of drop seals that fit to the bottom of a door and drop down automatically when the door closes to form a firm seal. Options include face-fixed installation, or fully mortising into door leaves.

A spring-loaded mechanism, requiring no power, ensures easy door operation and effective sealing when closed.

DROP SEALS

AAS8501 si

MORTISED **41dB**

A highly effective, self levelling drop seal with a unique wrap-around gasket for optimum acoustic and smoke containment. Coloured bands on the brass button help with fine adjustment for varying door gaps.

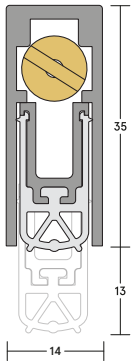

AAS8501 si



AAS8501 drop seal

DROP SEALS

SYSTEM SPECIFICATIONS

Test evidence

- ▶ Smoke: BS EN 1634-3: 2004 & BS 476-31.1: 1983 at ambient temperature.
- ▶ Acoustic: BS EN ISO 10140-2: 2010, BS EN ISO 10140-1: 2010 + A2: 2014 (Annex J) up to Rw 41dB.
- ▶ Durability: 100,000 cycles.

Characteristics

- ▶ Suitable for use on fire rated timber based door assemblies.
- ▶ Contributes towards sound, smoke, draught, and light containment.
- ▶ Suitable for wheeled traffic.

Location

- ▶ Single swing doors. For use on both right and left handed doors.

Use with

- ▶ Any perimeter seal. Any threshold plate.

Min/max gap size

- ▶ 1mm/13mm.

Seal material

- ▶ Grey or black silicone rubber.

Standard lengths

- ▶ 335mm, 435mm, 535mm, 635mm, 735mm, 835mm, 935mm, 1035mm, 1135mm and 1235mm. Sizes above 1235mm are available on request.
- ▶ Note: Each length can be cut back to the next size down. The 335mm can be cut back to 255mm.

Fixing

- ▶ Secured via stainless steel radiused end plates (21mm x 57mm). Two coloured bands on the adjuster indicate a nominal 10mm gap (blue) and the maximum 13mm gap (red), but any gap size from 1mm – 13mm can be accommodated

Adjustment

- ▶ Self-levelling on uneven surfaces.

Finishes

- ▶ Silver anodised aluminium with silver end plates, and grey silicone rubber gasket as standard.
- ▶ Silver anodised aluminium with bronze end plates, and black silicone rubber gasket are subject to non-standard charges and additional lead times.

Certification

certifire
(CF5179)



(R27972)

DROP SEALS

LAS8001 si

MORTISED **39dB**

A slimline, mortised automatic drop seal. It features a high efficiency mechanism, which lifts the seal clear of the floor as soon as the door is opened by a few millimetres; resulting in lower door operating forces. Requires no power connection. Self-levelling on uneven floors; seal height can be adjusted independently of fixing screws.

DROP SEALS

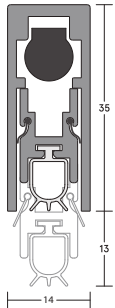

LAS8001 si



LAS8001 si (shown with LAS4001)

SYSTEM SPECIFICATIONS

Test evidence

- ▶ Fire: BS EN 1634-1:2014 + A1:2018 & BS 476-22:1987.
- ▶ Smoke: BS 476-31.1: 1983 at ambient temperature; BS EN 1634-3:2004 at ambient and medium temperature; effective smoke seal up to 200°C.
- ▶ Acoustic: BS EN ISO 10140-2:2010 (up to Rw 39dB).
- ▶ Durability: 100,000 cycles.

Characteristics

- ▶ Suitable for use on fire rated timber based door assemblies.
- ▶ Contributes towards sound, smoke, draught, and light containment.
- ▶ Suitable for wheeled traffic.

Location

- ▶ Single swing, single and double leaf doors. For use on both right and left handed doors.

Use with

- ▶ Any perimeter seal. Any threshold plate.

Min/max gap size

- ▶ 1mm/13mm.

Seal material

- ▶ Grey or black silicone rubber.

Standard lengths

- ▶ 335mm, 435mm, 535mm, 635mm, 735mm, 835mm, 935mm, 1035mm, 1135mm and 1235mm. Sizes above 1235mm are available on request.
- ▶ Note: Each length can be cut back to the next size down. The 335mm can be cut back to 255mm.

Fixing

- ▶ Fixing screws are supplied. This seal is mortised. Pre-drilled radiused end plates are supplied which also secure the product in place. (Square end plates available on request).

Adjustment

- ▶ Self-levelling on uneven surfaces.

Finishes

- ▶ Silver anodised aluminium with silver end plates, and grey silicone rubber gasket as standard.
- ▶ Silver anodised aluminium with bronze end plates, and black silicone rubber gasket are subject to non-standard charges and additional lead times.

Certification

certifire
(CF5179)

CLASSIFIED
UL
(R27972)

 **NBS Source**
PARTNER

DROP SEALS

LAS8001M

MORTISED

A slimline, mortised automatic drop seal for timber sliding doors. The end plate cleverly conceals a magnet which engages with a button in the frame, to assist the door closure and ensures the gasket remains in the dropped position without forcing the door open. The seal features a high efficiency mechanism, which lifts the seal clear of the floor as soon as the door is opened by a few millimetres; resulting in lower door operating forces.

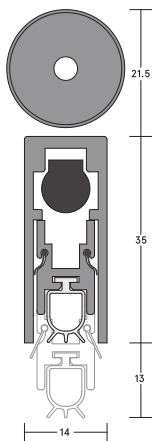

LAS8001M

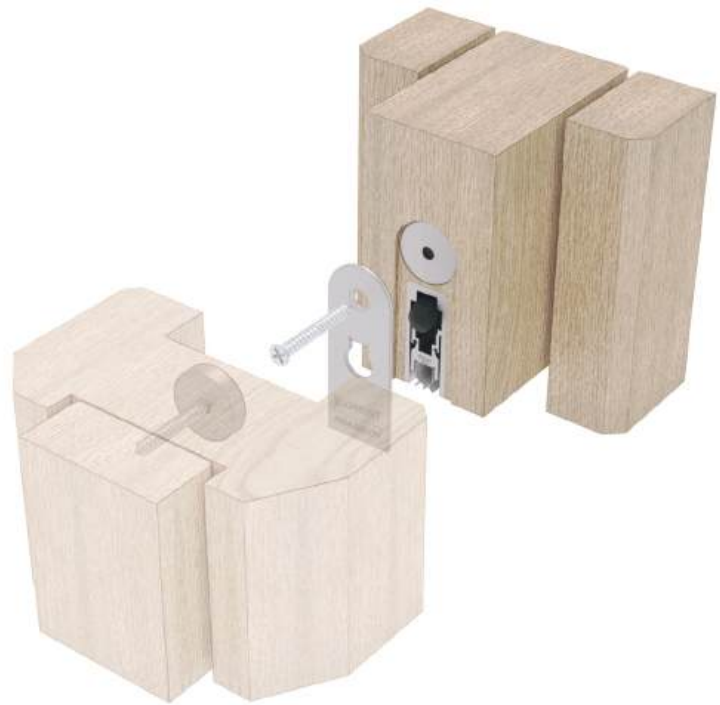

DROP SEALS

SYSTEM SPECIFICATIONS

Characteristics

- ▶ Meets threshold sealing requirement of BS 8214:2016 section 12.3.
- ▶ Contributes towards sound, draught, and light containment.
- ▶ Suitable for wheeled traffic.

Location

- ▶ Sliding doors.

Use with

- ▶ Any perimeter seal. Any threshold plate.

Min/max gap size

- ▶ 1mm/13mm.

Seal material

- ▶ Grey or black silicone rubber.

Standard lengths

- ▶ 335mm, 435mm, 535mm, 635mm, 735mm, 835mm, 935mm, 1035mm, 1135mm and 1235mm. Sizes above 1235mm are available on request.
- ▶ Note: Each length can be cut back to the next size down. The 335mm can be cut back to 255mm.

Fixing

- ▶ Fixing screws are supplied. This seal is mortised. Pre-drilled radiused end plates are supplied which also secure the product in place. (Square end plates available on request).
- ▶ Magnetised button is supplied to fix into the frame.

Adjustment

- ▶ Self-levelling on uneven surfaces. Can be adjusted independently of the fixing screws.

Finishes

- ▶ Silver anodised aluminium with silver end plates, and grey silicone rubber gasket as standard.
- ▶ Silver anodised aluminium with bronze end plates, and black silicone rubber gasket are subject to non-standard charges and additional lead times.
- ▶ Chrome finish magnetised button.

DROP SEALS

LAS8002 si

FACE-FIXED **31dB**

A slimline face-fixed automatic drop seal. It features a high efficiency mechanism, which lifts the seal clear of the floor as soon as the door is opened by a few millimetres; resulting in lower door operating forces. Surface mounted application suitable for upgrading existing doors. Requires no power connection. Self-levelling on uneven floors; seal height can be adjusted independently of fixing screws.



DROP SEALS

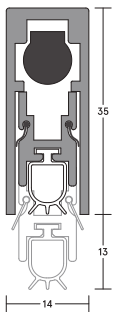

LAS8002 si



LAS8002 si (shown with LAS4001)

SYSTEM SPECIFICATIONS

Test evidence

- ▶ Smoke: BS 476-31.1: 1983 & BS EN 1634-3:2004 at ambient temperature.
- ▶ Acoustic: BS EN ISO 10140-2:2010 (up to Rw 31dB).

Characteristics

- ▶ Suitable for use on fire rated timber based door assemblies.
- ▶ Contributes towards sound, smoke, draught, and light containment.
- ▶ Suitable for wheeled traffic.

Location

- ▶ Single swing, single and double leaf doors.
- ▶ For use on both right and left handed doors.
- ▶ Suitable for use on timber based door assemblies.

Use with

- ▶ Any perimeter seal. Any threshold plate.

Min/max gap size

- ▶ 1mm/13mm.

Seal material

- ▶ Grey silicone rubber.

Standard lengths

- ▶ 335mm, 435mm, 535mm, 635mm, 735mm, 835mm, 935mm, 1035mm, 1135mm and 1235mm.
- ▶ Note: Each length can be cut back to the next size down. The 335mm can be cut back to 255mm.

Fixing

- ▶ LAS8002 si is face-fixed onto the door bottom.
- ▶ Screw fix using screws provided. Fit end caps.

Adjustment

- ▶ Self-levelling on uneven surfaces.
- ▶ Can be adjusted independently of the fixing screws.

Finishes

- ▶ Silver anodised aluminium with grey end caps and grey silicone rubber gasket as standard.
- ▶ Other powder-coated colour finishes (non-standard - charges and lead times apply).
- ▶ Black end caps, and black silicone rubber gasket (non-standard - charges and lead times apply).

Certification

certifire
(CF5179)



(R27972)



DROP SEALS

LAS8002G si

FACE-FIXED

A slimline face-fixed drop seal suitable for glass doors - hinged into timber or aluminium frames. A smooth back plate creates a visual aesthetic. LAS8002G si features a high efficiency mechanism, which lifts the seal clear of the floor as soon as the door is opened by a few millimetres; resulting in lower door operating forces.

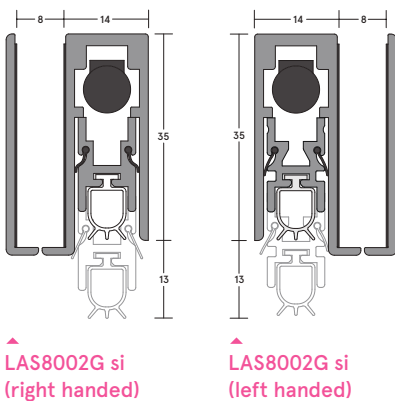

▲ LAS8002G si (shown with LAS4001)

DROP SEALS

SYSTEM SPECIFICATIONS

Characteristics

- ▶ Meets threshold sealing requirement of BS 8214:2016 section 12.3.
- ▶ Contributes towards sound, smoke, draught, and light containment.
- ▶ Suitable for wheeled traffic.

Location

- ▶ Single swing doors.
- ▶ For use on both right and left handed doors.

Use with

- ▶ Any perimeter seal. Any threshold plate.

Min/max gap size

- ▶ 1mm/10mm.

Seal material

- ▶ Grey silicone rubber.

Standard lengths

- ▶ 335mm, 435mm, 535mm, 635mm, 735mm, 835mm, 935mm, 1035mm, 1135mm and 1235mm.
- ▶ Note: Each length can be cut back to the next size down. The 335mm can be cut back to 255mm.

Fixing

- ▶ LAS8002G si carrier and back plate are face-fixed with strong adhesive tape.
- ▶ Fit end caps.
- ▶ This product is non-reversible and needs to be ordered left or right handed.

Adjustment

- ▶ Self-levelling on uneven surfaces.

Finishes

- ▶ Silver anodised aluminium with grey end caps and grey silicone rubber gasket as standard.
- ▶ Bronze anodised aluminium with black end caps and black silicone rubber gasket are subject to non-standard charges and additional lead times.
- ▶ Other powder-coated colour finishes (non-standard - charges and lead times apply).

DROP SEALS

LAS8003 si

FACE-FIXED **33dB**

A slimline face-fixed automatic drop seal. It features a high efficiency mechanism, which lifts the seal clear of the floor as soon as the door is opened by a few millimetres; resulting in lower door operating forces. Surface mounted application suitable for upgrading existing doors. Requires no power connection. Self-levelling on uneven floors; seal height can be adjusted independently of fixing screws.

ID No.
550

DROP SEALS

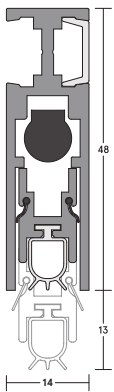

LAS8003 si



LAS8003 si (shown with LAS4100)

SYSTEM SPECIFICATIONS

Test evidence

- ▶ Smoke: BS 476-31.1: 1983 at ambient temperature.
- ▶ Acoustic: BS EN ISO 10140-2: 2010 (up to Rw 33dB).

Characteristics

- ▶ Suitable for use on fire rated timber based door assemblies.
- ▶ Contributes towards sound, smoke, draught, and light containment.
- ▶ Suitable for wheeled traffic.

Location

- ▶ Single swing, single and double leaf doors.
- ▶ For use on both right and left handed doors.

Use with

- ▶ Any perimeter seal. Any threshold plate

Min/max gap size

- ▶ 1mm/13mm.

Seal material

- ▶ Grey silicone rubber.

Standard lengths

- ▶ 335mm, 435mm, 535mm, 635mm, 735mm, 835mm, 935mm, 1035mm, 1135mm and 1235mm.
- ▶ Note: Each length can be cut back to the next size down. The 335mm can be cut back to 255mm.

Fixing

- ▶ LAS8003 si is face-fixed onto the door bottom. Fixing screws are provided.

Adjustment

- ▶ Self-levelling on uneven surfaces.
- ▶ Can be adjusted independently of the fixing screws.

Finishes

- ▶ Silver anodised aluminium with grey end caps and grey silicone rubber gasket as standard.
- ▶ Other powder-coated colour finishes (non-standard - charges and lead times apply).
- ▶ Black end caps, and black silicone rubber gasket (non-standard - charges and lead times apply).

Certification

certifire
(CF5179)



(R27972)



DROP SEALS

LAS8004 si

MORTISED

A mortised, automatic 'flat back' drop seal to suit installation to metal door rails. It features a high efficiency mechanism, which lifts the seal clear of the floor as soon as the door is opened by a few millimetres; resulting in lower door operating forces. Requires no power connection. Self-levelling on uneven floors; seal height can be adjusted independently of fixing screws.

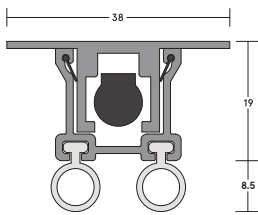

LAS8004 si

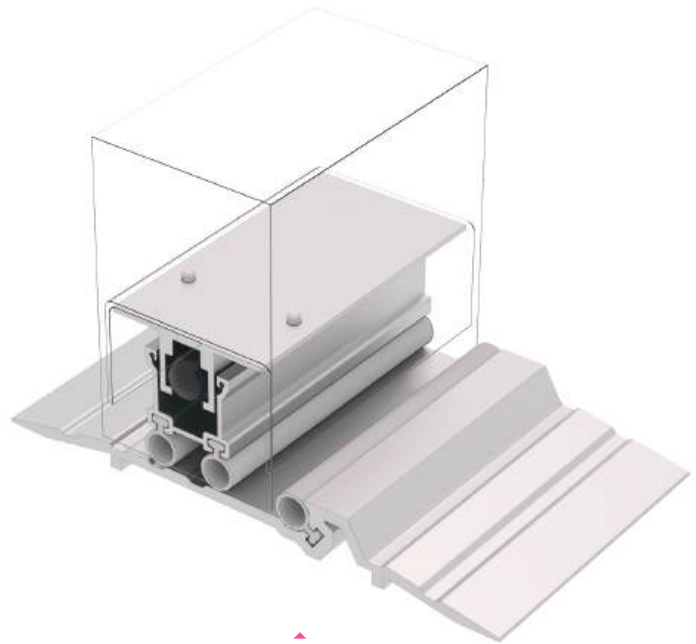

LAS8004 si
(shown with LAS4014 si)

DROP SEALS

SYSTEM SPECIFICATIONS

Test evidence

- ▶ Smoke: BS 476-31.1: 1983 at ambient temperature.
- ▶ Durability: 100,000 cycles.

Characteristics

- ▶ Suitable for use on fire rated steel based door assemblies.
- ▶ Contributes towards sound, smoke, draught, and light containment.
- ▶ Suitable for wheeled traffic.

Location

- ▶ Single swing, single and double leaf doors.
- ▶ Can be used on either right or left handed doors.

Use with

- ▶ Any threshold plate.

Min/max gap size

- ▶ 1mm/13mm.

Seal material

- ▶ Grey silicone gasket.

Standard lengths

- ▶ 635mm, 735mm, 835mm, 935mm, 1035mm, 1135mm and 1235mm.
- ▶ Note: Each length can be cut back to the next size down. The 635mm can be cut back to 535mm. Other lengths to special order.

Fixing

- ▶ Fixing screws are supplied, fixing holes are pre-drilled.

Adjustment

- ▶ Self-levelling on uneven surfaces.

Finish

- ▶ Silver anodised aluminium with grey gaskets.

Certification

certifire
(CF5179)



DROP SEALS

LAS8005 si

MORTISED **33dB**

A slimline, mortised automatic drop seal. It features a high efficiency mechanism, which lifts the seal clear of the floor as soon as the door is opened by a few millimetres; resulting in lower door operating forces. Requires no power connection. Self-levelling on uneven floors; seal height can be adjusted independently of fixing screws. Can be fitted to aluminium doors by door fabricators.

ID No.
270

DROP SEALS

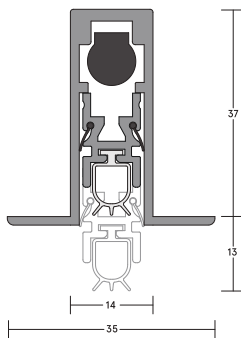

LAS8005 si

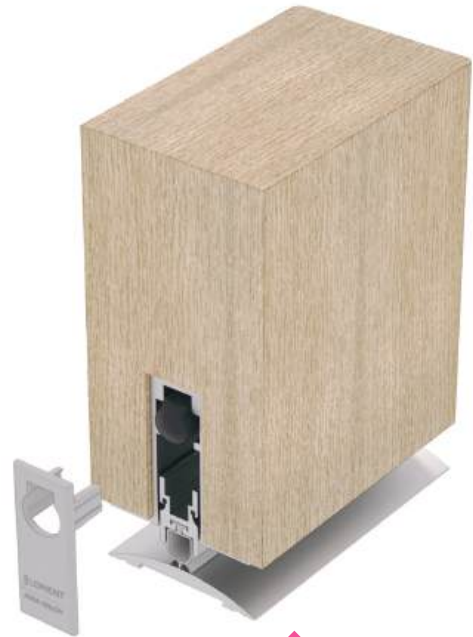

LAS8005 si
(shown with LAS4002)

SYSTEM SPECIFICATIONS

Test evidence

- ▶ Fire: BS 476-20/22:1987 & BS EN 1634-1:2014.
- ▶ Smoke: BS 476-31.1: 1983 & BS EN 1634-3:2004 at ambient temperature.
- ▶ Acoustic: BS EN ISO 10140-2:2010 (up to Rw 33dB).
- ▶ Durability: 100,000 cycles.

Characteristics

- ▶ Suitable for use on fire rated timber based door assemblies.
- ▶ Contributes towards sound, smoke, draught, and light containment.
- ▶ Suitable for wheeled traffic.

Location

- ▶ Single swing, single and double leaf doors.
- ▶ For use on both right and left handed doors.
- ▶ Suitable for use on timber based door assemblies.

Use with

- ▶ Any perimeter seal. Any threshold plate.

Min/max gap size

- ▶ 1mm/13mm.

Seal material

- ▶ Grey silicone rubber.

Lengths

- ▶ 335mm, 435mm, 535mm, 635mm, 735mm, 835mm, 935mm, 1035mm, 1135mm and 1235mm.
- ▶ Note: Each length can be cut back to the next size down. 335mm can be cut back to 255mm.

Fixing

- ▶ This seal is mortised, and screw fixed via the flanges.
- ▶ Fixing screws are supplied; fixing holes are pre-drilled and countersunk.

Adjustment

- ▶ Self-levelling on uneven surfaces. Seal height can be adjusted independently of the fixing screws.

Finishes

- ▶ Silver anodised aluminium with grey end caps and grey silicone rubber gasket as standard.
- ▶ Other powder-coated colour finishes (non-standard - charges and lead times apply).
- ▶ Black end caps, and black silicone rubber gasket (non-standard - charges and lead times apply).

Certification

certifire
(CF5179)

NBS Source
PARTNER



(R27972)

LORIENT
ASSA ABLOY

DROP SEALS

LAS8006 si

MORTISED **30dB**

A face-fixed automatic drop seal. It features a high efficiency mechanism, which lifts the seal clear of the floor as soon as the door is opened by a few millimetres; resulting in lower door operating forces. Requires no power connection. Self-levelling on uneven floors; seal height can be adjusted independently of fixing screws.

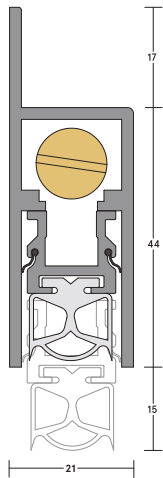

LAS8006 si



LAS8006 si (shown with LAS4010)

DROP SEALS

SYSTEM SPECIFICATIONS

Test evidence

- ▶ Smoke: BS 476-31.1: 1983 at ambient temperature.
- ▶ Acoustic: BS EN ISO 10140-2:2010 (up to Rw 30dB).

Characteristics

- ▶ Contributes towards sound, smoke, draught, and light containment.
- ▶ Suitable for wheeled traffic.

Location

- ▶ Single swing, single and double leaf doors.
- ▶ For use on both right and left handed doors.

Use with

- ▶ Any perimeter seal. Any threshold plate.

Min/max gap size

- ▶ 1mm/15mm.

Seal material

- ▶ Black or grey silicone rubber.

Standard lengths

- ▶ 335mm, 435mm, 535mm, 635mm, 735mm, 835mm, 935mm, 1035mm, 1135mm and 1235mm.
- ▶ Note: Each length can be cut back to the next size down. The 335mm can be cut back to 275mm.

Fixing

- ▶ Fixing screws are supplied, holes should be drilled at time of fixing

Adjustment

- ▶ Self-levelling on uneven surfaces – can be adjusted independently of the fixing screws.

Finishes

- ▶ Silver anodised aluminium with grey end caps and grey silicone rubber gasket as standard.
- ▶ Other powder-coated colour finishes (non-standard – charges and lead times apply).
- ▶ Black end caps, and black silicone rubber gasket (non-standard – charges and lead times apply).

Certification



(R27972)

DROP SEALS

LAS8007 si

MORTISED **39dB**

A mortised automatic drop seal. It features a high efficiency mechanism, which lifts the seal clear of the floor as soon as the door is opened by a few millimetres; resulting in lower door operating forces. Requires no power connection. Self-levelling on uneven floors; seal height can be adjusted independently of fixing screws. This is a fully-mortised version of LAS8006 si.

DROP SEALS

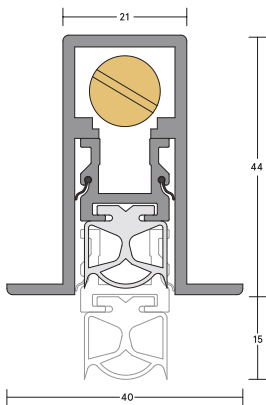

LAS8007 si



LAS8007 si (shown with LAS4011)

SYSTEM SPECIFICATIONS

Test evidence

- ▶ Smoke: BS 476-31.1: 1983 at ambient temperature.
- ▶ Acoustic: BS EN ISO 10140-1:2010+A2: 2014 (Annex J) up to Rw 39dB.

Characteristics

- ▶ Contributes towards sound, smoke, draught, and light containment.
- ▶ Suitable for wheeled traffic.

Location

- ▶ Single swing, single and double leaf doors.
- ▶ For use on both right and left handed doors.

Use with

- ▶ Any perimeter seal. Any threshold plate.

Min/max gap size

- ▶ 1mm/15mm.

Seal material

- ▶ Black or grey silicone rubber.

Standard lengths

- ▶ 335mm, 435mm, 535mm, 635mm, 735mm, 835mm, 935mm, 1035mm, 1135mm and 1235mm.
- ▶ Note: Each length can be cut back to the next size down. The 335mm can be cut back to 275mm.

Fixing

- ▶ Fixing screws and end caps are supplied.
- ▶ Fixing holes are pre-drilled through the flanges.

Adjustment

- ▶ Self-levelling on uneven surfaces - can be adjusted independently of the fixing screws.

Finishes

- ▶ Silver anodised aluminium with grey end caps and grey silicone rubber gasket as standard.
- ▶ Other powder-coated colour finishes (non-standard - charges and lead times apply).
- ▶ Black end caps, and black silicone rubber gasket (non-standard - charges and lead times apply).

Certification



(R27972)

DROP SEALS

LAS8008 si

FACE-FIXED **30dB**

A slimline face-fixed automatic drop seal with a curved cover plate for enhanced aesthetics. It features a high efficiency mechanism, which lifts the seal clear of the floor as soon as the door is opened by a few millimetres; resulting in lower door operating forces. Requires no power connection. Self-levelling on uneven floors, seal height can be adjusted independently of fixing screws. Suitable for upgrading existing doors.

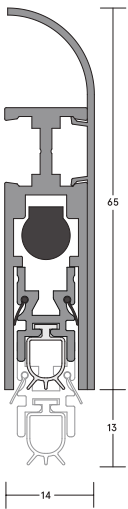

▲ LAS8008 si



▲ LAS8008 si (shown with LAS4011)

DROP SEALS

SYSTEM SPECIFICATIONS

Test evidence

- ▶ Smoke: BS 476-31.1: 1983 & BS EN 1634-3:2004 at ambient temperature.
- ▶ Acoustic: BS EN ISO 10140-2: 2010 (up to Rw 30dB).

Characteristics

- ▶ Contributes towards sound, smoke, draught, and light containment.
- ▶ Suitable for wheeled traffic.

Location

- ▶ Single swing, single and double leaf doors.
- ▶ For use on both right and left handed doors.

Use with

- ▶ Any perimeter seal. Any threshold plate.

Min/max gap size

1mm/13mm.

Seal material

- ▶ Grey silicone rubber.

Standard lengths

- ▶ 335mm, 435mm, 535mm, 635mm, 735mm, 835mm, 935mm, 1035mm, 1135mm and 1235mm.
- ▶ Note: Each length can be cut back to the next size down. The 335mm can be cut back to 255mm.

Fixing

- ▶ Fixing screws are supplied, holes should be drilled at time of fixing. LAS8008 si is face-fixed only.

Adjustment

- ▶ Self-levelling on uneven surfaces.
- ▶ Can be adjusted independently of the fixing screws.

Finishes

- ▶ Silver anodised aluminium with grey end caps and grey silicone rubber gasket as standard.
- ▶ Other powder-coated colour finishes (non-standard - charges and lead times apply).
- ▶ Black end caps, and black silicone rubber gasket (non-standard - charges and lead times apply).

DROP SEALS

LAS8009 si

HEAVY DUTY **31dB**

A face-fixed automatic drop seal with curved cover plate that conceals fixing screws and presents an exceptionally smooth external aspect. It features a high efficiency mechanism, which lifts the seal clear of the floor as soon as the door is opened by a few millimetres; resulting in lower door operating forces. Requires no power connection. Self-levelling on uneven floors; seal height can be adjusted independently of fixing screws.

DROP SEALS

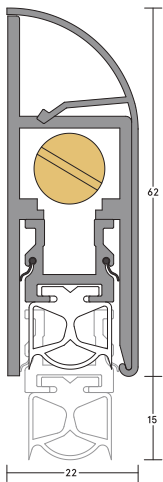

LAS8009 si



LAS8009 si (shown with LAS4010)

SYSTEM SPECIFICATIONS

Test evidence

- ▶ Smoke: BS 476-31.1: 1983 at ambient temperature.
- ▶ Acoustic: BS EN ISO 10140-2: 2010 (up to Rw 31dB).

Characteristics

- ▶ Contributes towards sound, smoke, draught, and light containment.
- ▶ Suitable for wheeled traffic.

Location

- ▶ Single swing, single and double leaf doors.
- ▶ For use on both right and left handed doors.

Use with

- ▶ Any perimeter seal. Any threshold plate.

Min/max gap size

- ▶ 1mm/15mm.

Seal material

- ▶ Black or grey silicone rubber.

Standard lengths

- ▶ 335mm, 435mm, 535mm, 635mm, 735mm, 835mm, 935mm, 1035mm, 1135mm and 1235mm.
- ▶ Note: Each length can be cut back to the next size down. The 335mm can be cut back to 275mm.

Fixing

- ▶ Fixing screws are supplied, holes should be drilled at time of fixing. End caps are supplied.

Adjustment

- ▶ Self-levelling on uneven surfaces – can be adjusted independently of the fixing screws.

Finishes

- ▶ Silver anodised aluminium with grey end caps and grey silicone rubber gasket as standard.
- ▶ Other powder-coated colour finishes (non-standard – charges and lead times apply).
- ▶ Black end caps, and black silicone rubber gasket (non-standard – charges and lead times apply).

Certification



(R27972)



NBS Source
PARTNER

DROP SEALS

LAS8014 si

MORTISED **47dB**

A durable, automatic drop seal featuring a wrap-around outer gasket with an additional internal gasket designed for superior acoustic performance. The seal features a parallel drop mechanism. It is spring-loaded to lift clear of the floor as soon as the door is opened by a few millimetres.

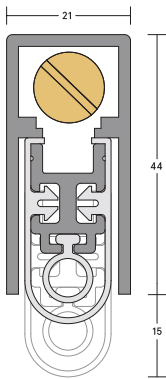

▲ LAS8014 si



▲ LAS8014 si (shown with LAS4002)

DROP SEALS

SYSTEM SPECIFICATIONS

Test evidence

- ▶ Smoke: BS EN 1634-3:2004 at ambient temperature.
- ▶ Acoustic: BS EN ISO 10140-1: 2010+A2: 2014 (Annex J) up to Rw 47dB.
- ▶ Durability: 1 million cycles.

Characteristics

- ▶ Contributes towards sound, smoke, draught, and light containment.
- ▶ Suitable for wheeled traffic.
- ▶ Parallel drop mechanism.

Location

- ▶ Single swing, single and double leaf doors.
- ▶ For use on both right and left handed doors.

Use with

- ▶ Any perimeter seal. Any threshold plate.

Min/max gap size

- ▶ 6mm/15mm.

Seal material

- ▶ Grey silicone rubber.

Standard lengths

- ▶ 335mm, 435mm, 535mm, 635mm, 735mm, 835mm, 935mm, 1035mm, 1135mm and 1235mm.
- ▶ Note: Other lengths can be cut back to the next size down. The 535mm can be cut back to 495mm. The 335mm can be cut back to 255mm.

Fixing

- ▶ Pre-drilled end plates are supplied which also secure the product in place. Fixing screws are supplied.
- ▶ Both square and radiused end plates are available - state your preference at point of order.

Adjustment

- ▶ Self-levelling on uneven surfaces - can be adjusted independently of the fixing screws.

Finishes

- ▶ Silver anodised aluminium, grey silicone rubber gasket as standard.
- ▶ The non-button end cap is designed blank, creating an engineered smooth aesthetic.

DROP SEALS

LAS8040

MORTISED **40dB**

A mortised automatic drop seal. The unique double activated mechanism has an adjustable brass striker button at the hinge side and a nylon striker at the latch side. The mechanism also contains additional internal seals and a double compression facility to provide exceptional acoustic performance. Can be used for both 44mm and 54mm doors.



DROP SEALS

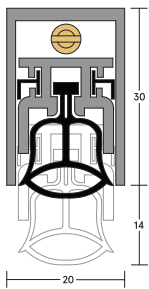

↑ LAS8040



↑ LAS8040 (shown with LAS4001)

SYSTEM SPECIFICATIONS

Test evidence

- ▶ Acoustic: BS EN ISO 10140-2:2010 (up to Rw 40dB).

Characteristics

- ▶ Meets threshold sealing requirement of BS 8214:2016 section 12.3.
- ▶ Contributes towards sound, smoke, draught, and light containment.
- ▶ Suitable for wheeled traffic.

Location

- ▶ Single swing, single leaf doors. For use on both right and left handed doors.

Use with

- ▶ Any perimeter seal.
- ▶ Any threshold plate.

Min/max gap size

- ▶ 3mm/14mm.

Seal material

- ▶ Flexible thermoplastic elastomer gasket and internal fins.

Fixing

- ▶ Appropriate fixing screws are supplied, fixing holes are pre-drilled.
- ▶ Striker plates, which are located in the door jambs are supplied. This seal must be mortised.

Adjustment

- ▶ Self-levelling on uneven surfaces - can be adjusted independently of fixing screws. Adjust using the buttons at either end of the seal.

Finish

- ▶ Silver anodised aluminium with black flexible gasket.

Seal	Length	Cut back	Cut location
LAS8040	535mm	80mm	Brass button end
LAS8040	635mm	100mm	50mm from each end
LAS8040	735mm	100mm	50mm from each end
LAS8040	835mm	100mm	50mm from each end
LAS8040	935mm	100mm	50mm from each end
LAS8040	1035mm	100mm	50mm from each end
LAS8040	1135mm	100mm	50mm from each end

FINGER GUARDS & SPECIALITY SEALS

A range of speciality seals that features finger guards, a drip guard and a flush bolt + drop seal.

Trapping fingers in hinged doors can cause horrendous injuries.

The risk is especially high where young children are present. Our finger guard seals provide a shield, helping prevent thousands of accidents.



SPECIALITY SEALS

LAS9001

FACE-FIXED

An overhead drip guard designed to channel rain water away from exposed doors, particularly those which open outward. Can also be used to deflect rainwater from the bottom of the door.

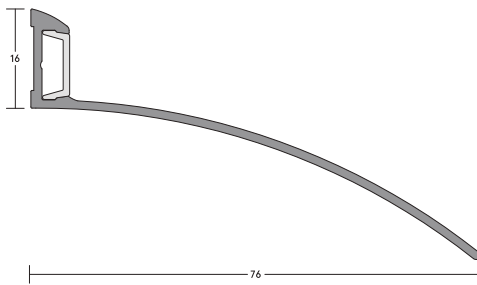

LAS9001



SYSTEM SPECIFICATIONS

Characteristics

- ▶ Protects against weather/rain.

Location

- ▶ Single and double leaf doors.
- ▶ Sliding doors.
- ▶ Roller shutter doors.
- ▶ Up and over doors.

Seal material

- ▶ Extruded aluminium.

Standard lengths

- ▶ 1m and 2.1m.

Fixing

- ▶ Steel screws are supplied (self-drilling and self-tapping screws for metal construction available on request).
- ▶ A PVC cover strip conceals the fixings.
- ▶ Allow an overlap of 50mm on each side of door opening.

Finish

- ▶ Silver anodised aluminium.

LAS9010 / LAS8001 si

MORTISED

35dB

An innovative, slimline flush bolt designed for both the top and bottom of the door, seamlessly integrating with our most popular drop seal – LAS8001 si. The flush bolt is a security device used on pairs of doors to secure the inactive leaf. It is activated by a discreet Lorient-branded lever, dropping the bolt into a sleek keep in the floor. Specifically designed for use with our rebated high-performance drop seal, this system provides the ultimate combination of security with smoke, acoustic, and energy containment at both the top and bottom of the door.

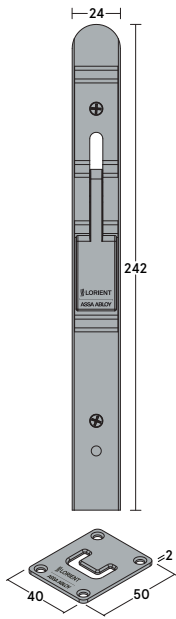

LAS9010



Bottom of the door



Top of the door

Patent No. 1718821

SYSTEM SPECIFICATIONS

Test evidence

- ▶ Fire: BS EN 1634-1:2014+A1:2018 in an FD30 & FD60.
- ▶ Smoke: BS EN 1634-3:2004 at ambient temperature.
- ▶ Acoustic: BS EN ISO 10140-2:2010 (up to Rw 35dB).
- ▶ Classified to BS EN 12051: 2000.
- ▶ Durability: 50,000 cycles.

Characteristics

- ▶ Contributes towards sound, smoke, draught, and light containment.
- ▶ LAS9010 is a security device. Its unique wrap-around shape of bolt enhances smoke & acoustic performance.
- ▶ Flush bolt integrates seamlessly with the drop seal; no extra kits required.
- ▶ Smooth locking action with branded levers.
- ▶ Does not penetrate the drop seal gasket.

Min/max gap size

- ▶ 1mm/13mm.

Location

- ▶ Double doors.
- ▶ For use on both right & left handed doors.
- ▶ Suitable for bottom & top of the door.

Material

- ▶ Flush bolt – brushed stainless steel.
- ▶ Seal material – grey or black silicone rubber.

Drop seal standard lengths

- ▶ 335mm, 435mm, 535mm, 635mm, 735mm, 835mm, 935mm, 1035mm, 1135mm + 1235mm.
- ▶ Note: each length can be cut to the next size down. The 335mm can be cut back to 255mm.

Fixing

- ▶ LAS9010 is semi-mortised into the top and bottom of the door.
- ▶ Fixing screws are supplied.
- ▶ Flush bolt is positioned into the keep.
- ▶ Drop seal end plate is not required on one side i.e. at meeting stile.
- ▶ No extra adapter kits required.

Use with

- ▶ All standard lengths of LAS8001 si, with the ability to cut to size.
- ▶ *Cladding kits must be used for fire rated variants.

How to order

- ▶ Kit 1: Non-fire rated bottom of the door flush bolt + drop seal.
- ▶ Kit 2: FD60 flush bolt + drop seal bottom of the door with cladding kit.
- ▶ Kit 4: FD30 flush bolt + drop seal bottom of the door.

Addition options:

- ▶ Flush bolt for top of the door only. Options: Non-fire rated, FD30 or FD60.
- ▶ Flush bolt for bottom of the door only (no drop seal). Options: Non-fire rated, FD30 or FD60.

Classification



LAS9030

FACE-FIXED

A durable safety finger guard seal, which provides a deterrent to fingers becoming jammed on the hinge cavity side of a door. The product is fixed to the door and the jamb on the hinge cavity side. Trapping fingers in hinged doors can cause horrendous injuries. The risk is especially high in locations where young children are present. To be used in conjunction with LAS9050 si finger guard seal for the hinge knuckle side.

FINGER GUARDS / SPECIALITY SEALS



LAS9030

LAS9030
(shown with LAS9050 si)

SYSTEM SPECIFICATIONS

Test evidence

- ▶ Tested to BS 8613:2017 (Finger protection devices for pedestrian doors - Type A, Class 2).
- ▶ Durability: 300,000 cycles.

Characteristics

- ▶ Contributes towards sound, smoke, draught, and light containment.
- ▶ Suitable for wheeled traffic.

Location

- ▶ Jambes of hinged doors. It can be used on doors with an opening of 170° when used with LAS9050 si. 180° can be obtained when LAS9030 is used on its own.

Use with

- ▶ LAS7001 si perimeter seal and LAS8001 si drop seal (fully mortised).

Seal material

- ▶ Black EPDM rubber.

Standard lengths

- ▶ 2.1m. Other lengths to special order.

Fixing

- ▶ Self-tapping wood screws are supplied (self-drilling and self-tapping screws for metal construction available on request)
- ▶ Fixing holes are pre-drilled and slotted to allow the seals to be adjusted and positioned accurately. PVC cover strips to conceal fixings are supplied.

Finishes

- ▶ Silver anodised aluminium with grey cover strip and black gasket as standard.
- ▶ Bronze anodised aluminium with black cover strip and black gasket are subject to non-standard charges and additional lead times.

Specification



LAS9050 si & LAS9070 si

FACE-FIXED

This medium duty finger guard seal system provides a shield to trapping fingers in hinged doors, which can cause horrendous injuries. Protects both sides of the door by using the LAS9050 si on the hinge knuckle side and the LAS9070 si on the hinge cavity side.

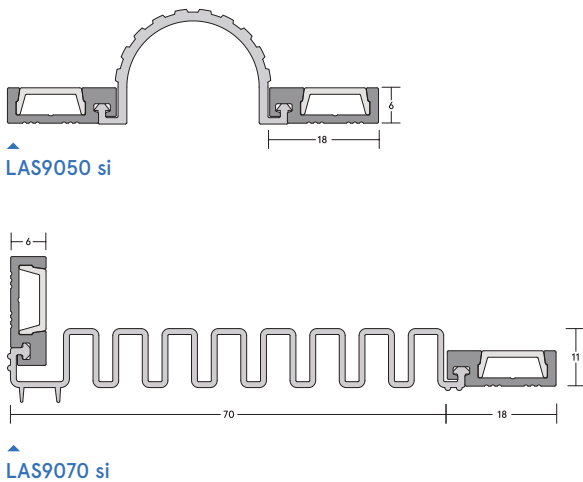

SYSTEM SPECIFICATIONS

Test evidence

- ▶ Tested to BS 8613:2017 (Finger protection devices for pedestrian doors - Type A, Class 1).

Characteristics

- ▶ Contributes towards sound, smoke, draught, and light containment.
- ▶ Suitable for wheeled traffic.

Location

- ▶ Jambs of hinged doors. LAS9070 si can be used on doors with an opening of 180°.

Use with

- ▶ LAS7001 si perimeter seal and LAS8001 si drop seal (fully mortised).

Seal material

- ▶ Silicone.

Standard lengths

- ▶ 2.1m. Other lengths to special order. Single doorset packs are available containing 1 x 2.1m LAS9050 si and 1 x 2.1m LAS9070 si.

Fixing

- ▶ Self-tapping wood screws are supplied (self-drilling and self-tapping screws for metal construction available on request).
- ▶ Fixing holes are pre-drilled and slotted to allow the seals to be adjusted and positioned accurately. PVC cover strips to conceal fixings are supplied.

Finishes

- ▶ Silver anodised aluminium with grey cover strip and black gasket as standard.
- ▶ Bronze anodised aluminium with black cover strip and black gasket are subject to non-standard charges and additional lead times.
- ▶ Black or brown gaskets are available to special order (non-standard - charges and lead times apply).

Specification



CPDs

We offer four fully-accredited CPD seminars. Impartially presented by knowledgeable speakers, the seminars are structured to be technically informative, and provide practical advice.



The Importance of Fire Doors & Intumescent Seals

Fire doors and intumescent seals are critical components in fire safety, designed to prevent the spread of fire and smoke, saving lives and protecting property. This CPD explores their essential role in passive fire protection.

The CPD seminar covers:

- ▶ hard facts concerning deaths, injuries and property damage caused by fire and smoke;
- ▶ fire testing in the UK and the applicable fire and smoke leakage standards;
- ▶ how ironmongery affects fire doors and the vital role of intumescent protection;
- ▶ understanding intumescent seals for doors and the importance of third party certification;
- ▶ practical product solutions.

RIBA Core curriculum:

- ▶ Health, Safety & Wellbeing
- ▶ Legal, regulatory and statutory compliance

The Role and Performance of Fire & Smoke-Resisting Door Assemblies

The importance of fire and smoke resisting door assemblies is illustrated by the 216 fire related fatalities and 5,545 casualties in fires (England 2022/23). Apart from the human toll, property losses each year approach £2.52 billion.

The CPD seminar covers:

- ▶ hard facts concerning deaths, injuries and property damage caused by fire and smoke;
- ▶ regulatory requirements for fire and smoke resisting door assemblies;
- ▶ the nature and behaviour of smoke;
- ▶ effective design of door assemblies for smoke containment, including the threshold gap;
- ▶ design conflicts between fire containment, smoke containment, durability and ease of operation of the door;
- ▶ independent accreditation.

RIBA Core curriculum:

- ▶ Health, Safety & Wellbeing
- ▶ Legal, regulatory and statutory compliance
- ▶ Design, construction & technology

The Regulatory Reform (Fire Safety) Order 2005 & its implications for fire doors

The RRO consolidated 70 pieces of legislation; shifted responsibility for fire safety management; abolished the Fire Safety Certificate; established the Fire Risk Assessment and created major change in legal liability.

The CPD seminar covers:

- ▶ quick introduction to the RRO and who is responsible for a building's fire safety;
- ▶ examples of companies who have come under fire from the RRO;
- ▶ the dangers of fire and smoke;
- ▶ the importance of fire doors – including installation and maintenance.
- ▶ examples of poorly maintained and fitted fire doors with cost effective solutions.
- ▶ independent accreditation.

RIBA Core curriculum:

- ▶ Health, Safety & Wellbeing
- ▶ Design, construction & technology



Four of our CPD seminars have been independently verified and certified by RIBA. A certificate for 1 hour's CPD will be provided, which contributes to Continuing Professional Development requirements. RIBA-approved CPD earns Chartered Architects double points.

Performance Door Design: The Basics of Sound Reduction

Effective acoustic containment helps to improve the quality of the built environment, preserving privacy as well as excluding unwanted noise. With changing regulations, it's essential to be informed of the relevant requirements and the implications for door assemblies.

The CPD seminar covers:

- ▶ the nature of sound, examining airborne transmission of sound;
- ▶ regulatory requirements and British Standards that relate to acoustic performance;
- ▶ test procedures and interpretation of test reports;
- ▶ effective design of door assemblies for acoustic performance, including door construction and the influence of sealing systems;
- ▶ design conflicts between acoustic performance, durability and ease of operation of the door;
- ▶ independent accreditation.

RIBA Core curriculum:

- ▶ Legal, regulatory and statutory compliance
- ▶ Design, construction & technology.

The Design & Specification of Air Transfer Grilles / Dampers

Intumescent air transfer grilles enable ventilation while ensuring fire protection. Under normal conditions, they allow airflow, but in a fire, they expand to block fire, hot smoke, and gases. Combined fire and smoke grilles are designed for cold smoke containment. Correct specification is critical to ensure effective fire protection and safety in building design.

The CPD seminar covers:

- ▶ the latest test standards and building regulations;
- ▶ the major difference between intumescent air transfer grilles and dampers;
- ▶ the importance of correct specification, installation and maintenance;
- ▶ plus it offers practical solutions to fire and smoke containment over a range of applications.

Non-accredited.

Each informative seminar provides an opportunity to keep up-to-date with all the latest facts about fire, smoke and acoustic containment, including regulations and standards – as well as exploring practical solutions.

Registered RIBA members can claim double points for our RIBA accredited CPD materials; and all attendees will receive one-hour's CPD for each seminar.

If CPD certification is not required, presentations can be tailored to suit a wide variety of audiences, including client companies, building contractors, construction industry groups and trade associations.



To find out more or to book, contact us:

cpd@lorientuk.com

www.lorientuk.com

ADDITIONAL INFORMATION

TECHNICAL REFERENCES

Lorient is quality assured under the disciplines of BS EN ISO 9001:2015.

Accreditation to this standard is an assurance that we conduct our business to the complete satisfaction of our customers with regard to design solutions, manufacturing consistency and management procedures.

As a result, this internationally recognised standard for quality management generates customer confidence. Regular audits of our company procedures are undertaken by qualified BSI staff to ensure ongoing compliance with all aspects of the standard.



BS EN ISO 9001:2015 Certificate No. Q 06104

Lorient has attained the BS EN ISO 14001:2015 accreditation for environmental management. This internationally recognised standard shows that we have demonstrated our commitment to responsible environmental behaviour, including prevention of pollution, control and reduction of waste, and ongoing monitoring and improvement of our environmental performance. Achieving ISO 14001 is just one part of our ongoing commitment to operate in a sustainable way.



BS EN ISO 14001:2015 Certificate No. EMS 800254

FITTING INSTRUCTIONS

Comprehensive fitting instructions are available to download from our website www.lorientuk.com

COMPATIBILITY

All Lorient Architectural Seals are compatible with the materials normally used in doors and door frames, including wood, steel, PVC, aluminium and glass.

Please Note: Recommendations as to methods, use of materials and construction details are based on the experience and knowledge of Lorient and are given in good faith as a general guide and a service to designers, contractors and manufacturers.

GUARANTEE OF ORIGIN

Each production batch of Lorient seals is laser engraved unobtrusively on the edge of the profile with the Lorient name and a code reference. This ensures the product and details of its production can be traced should the need arise.

Unidentifiable substitute products should never be accepted.

MADE IN BRITAIN

We are proud to have been granted the prestigious Made in Britain marque for our products, designed and manufactured at our main facility in South West of the UK.



INTELLECTUAL PROPERTY

© 2025 Lorient – this brochure is protected by copyright and neither the drawings nor the text may be reproduced or transmitted in any form without prior consent from Lorient. Lorient products described in this brochure are protected by patents and design registrations in Great Britain and other countries.

We are committed to continually enhancing and improving our product range. We reserve the right to change product specifications from time to time without prior notice. E&OE.

January 2025.

TRADE ASSOCIATIONS

Lorient is a member and active contributor to the following:



ACCREDITATIONS

BBA

BBA approvals provide independent assurance for the designer, specifier and end-user as to the 'fitness for purpose' of building products.



CERTIFIRE

Operated by Exova Warringtonfire, CERTIFIRE is an accredited independent product conformity scheme that requires products to meet the requirements of the tests, to add minimal resistance to opening and closing forces, to prove long term performance under a variety of service conditions, and to be permanently marked for easy identification.



IFC

IFC Certification Ltd is a UKAS approved and internationally recognised provider of third party Certification services – designed to give confidence to specifiers, users, occupiers, owners and enforcement bodies that products have been thoroughly and independently evaluated and will continue to be manufactured to the same specification as originally tested.



UL

UL is a global independent safety science company that tests a diverse range of products; representative samples of a product must be tested and meet UL's stringent requirements to carry the marque. These requirements are based primarily on UL's published and nationally recognised Standards for Safety. Businesses, consumers and regulatory authorities around the world recognise the trusted rigour and technical excellence of UL certifications. Lorient is proud to have achieved the UL Mark on many of its products. These are detailed on individual pages.



COMPREHENSIVE SUPPORT

We continue to lead the way in Research + Development. As a company we have over 45 years' experience, so our experts are well equipped to listen, help and advise you on your sealing system requirements.

Online Acoustic Search tool

Our Acoustic Search tool on our website gives you quick and easy access to a wide range of tested acoustic sealing systems on a variety of popular door constructions & configurations.

www.lorientuk.com/acousticsearch

The tool allows users to select a specific decibel rating; along with door configuration, fire door rating, doorset type etc to filter the results.

If you're looking for high performance or specialist applications – please contact us, there may be some additional configurations we haven't yet published.



Web Support

Our website features a comprehensive range of supporting documents covering the entire range of products, including installation guides and CAD drawings. All of our brochures and products sheets are also available for download, together with copies of certification and specification texts

Online ATG Product Selector

The ATG Product Selector on our website provides quick and easy access to a wide range of tested air transfer grille applications for doors, walls, and ducts.

www.lorientuk.com/grilles

This intuitive tool allows users to select an intumescent air transfer grille based on several critical factors, including application, fire resistance, integrity, and insulation. Our comprehensive database ensures that you can find the right product to meet your specific needs.

If you need help specifying the right air transfer grilles for your project, our technical team are here to help.



Technical Services

We're happy to provide specialist advice on acoustic, smoke and fire protection for refurbishment and new build projects. If you need assistance, you can call our Technical Services team.

Alternatively, we can arrange a site visit to get a clearer idea of your needs and how we can help you. We also provide copies of test reports and samples where needed; and can give guidance on how best to meet Building Regulations and Standards.

Customisation

If you have a particular requirement which isn't covered by the applications in this brochure, we may be able to supply an existing non-standard item, or even develop a customised solution for you. Utilising in-house expertise, bespoke products are created to your requirements; from a functional or aesthetic perspective, or both.

Lorient's dedicated Technical Services team supports and works as part of your design team, offering informed product advice and guidance on regulatory requirements and standards.



Call our Technical Services team

+44 (0) 1626 834252

www.lorientuk.com

MAINTENANCE GUIDE

Lorient products are generally regarded as low maintenance; however periodic inspection and cleaning is recommended for all types of seals. For care and maintenance information of Lorient products follow these guidelines.

Maintenance Inspection

All products should be inspected every **12 months**.

Aluminium & Gasket Products

Lorient aluminium and gasket products can be cleaned with mild soap and warm water.

A non-abrasive cloth should be used to clean the surface of these products followed by mild soap mixed with warm water. Allow to air dry or wipe dry with a chamois, squeegee, or lint-free cloth.

The use of strong solvents or cleaner concentrations may cause damage to the surface and is not recommended.

Check all products are securely attached to the door or frame in accordance with Lorient's installation instructions. Re-attach where necessary.

Drop Seals

Check the drop seal is functioning correctly, deploying and retracting fully. Check release knob, sealing gasket and lift height. Check the gasket is intact and undamaged. If the gasket is damaged, it must be replaced with like for like. Clean as above and adjust if necessary.

Batwing Seals

Check that the seal including any fins are intact, undamaged and fixed in position. If damaged or missing replace with the like for like fire seal. If fins are overpainted replace with like for like.

Brush Seals

The appearance and performance of brush seals will benefit from a wipe with a damp cloth at least once a year. Worn or damaged seals should be replaced without delay.

Note

Recommendations as to cleaning methods are based on the experience and knowledge of Lorient and are given in good faith as a general guide.



TESTING + TECHNICAL SERVICES

We've built our reputation on the quality and dependability of our products, and our investment in R&D has played a pivotal role in keeping our products at the forefront of our industry. Our dedicated Testing and Technical Services division has established itself as an important facility for manufacturers and designers of doors, windows, glazing systems and hardware, to name just a few.

TESTING SERVICES

Whether you're investigating new materials, or developing new or existing products, right through to durability testing and benchmarking performance – our team of experts will support you throughout the process. We are able to offer:

- ▶ Fire testing (indicative)
- ▶ Smoke leakage
- ▶ Air leakage
- ▶ ATG commissioning and maintenance for fire & smoke resisting air transfer grilles
- ▶ Mechanical cycling
- ▶ Environmental chamber analysis
- ▶ Attendance at external fire tests
- ▶ Consultancy services.



▲
Lorient Indicative Furnace

SEALING SOLUTIONS

Detailed information about our products can be found in the following brochures:



Lorient Architectural Seals

A variety of door sealing systems including perimeter seals, drop seals, threshold plates, door bottom seals and many more.

Fire, Smoke and Acoustic Seals for Door Assemblies

Our core range of high performance fire, smoke and acoustic seals.

Fire and Smoke Resistant Air Transfer Grilles

A comprehensive range of fire, and fire and smoke resistant intumescent air transfer grilles for doors, walls, ducts, floors and ceilings.

Fire Resistant Door Hardware Protection

Letterplates, door edge protectors and intumescent kits that can safely be installed into fire rated doors without compromising the fire/smoke performance.

Fire Resistant Glazing Systems

Fire resistant glazing systems for doors, screens and partitions

Acoustic Sealing Systems for Door Assemblies

A comprehensive series of acoustic sealing systems for various types of door construction.

Copies of these brochures are available by calling **+44 (0)1626 834252** or download from our website www.lorientuk.com



UK / EUROPE

T: +44 (0) 1626 834252
E: sales@lorientuk.com

AUSTRALIA

T: +61 (0) 3 8574 3888
E: customerservice.au@assaabloy.com

SINGAPORE

T: +65 6880 0000
E: sales.lorient@assaabloy.com

HONG KONG

T: +852 2260 0888
E: sales.hk@assaabloy.com

UAE

T: +971 4 8804888
E: mktg@lorientuk.com

USA

T: +1 859 252 7441
E: info@lorientna.com

For further information about
Lorient products please visit:
www.lorientgroup.com



@lorientuk



/company/lorient



@lorientuk



@lorientuk



@lorientuk



@lorientuk