

 **LORIENT**

**ASSA ABLOY**

**ARCHITECTURAL**  
**SEALS**

ARCHITECTURAL  
TECTU  
SEALS





# We've been designing and manufacturing high performance sealing systems for over 40 years.

**And we're passionate about the products we make. Our dedicated R+D and testing facilities rigorously put our sealing systems through their paces – enabling us to enhance product form and function. We've built a strong reputation for design innovation; and for producing the highest quality sealing systems embracing acoustic, smoke, fire and thermal containment; as well as accessibility.**

Respected throughout the industry for our technical expertise, we play an active role in helping to shape standards and best practice. We believe in providing excellent levels of customer service; and are at our best working in partnership with you.

The Lorient Architectural Seals range incorporates a variety of complementary door sealing systems including perimeter seals, drop seals, threshold plates, door bottom seals plus much more. These seals can provide outstanding protection for all four sides of the door against sound, smoke, fire, rain, light, draughts, dust and even insects.

Manufactured to the highest quality standards, Lorient Architectural Seals have been designed and tested for a host of different applications in a variety of sectors throughout commercial, industrial and public buildings.

**MADE IN  
BRITAIN** 

# SEALING DOORS WORLDWIDE

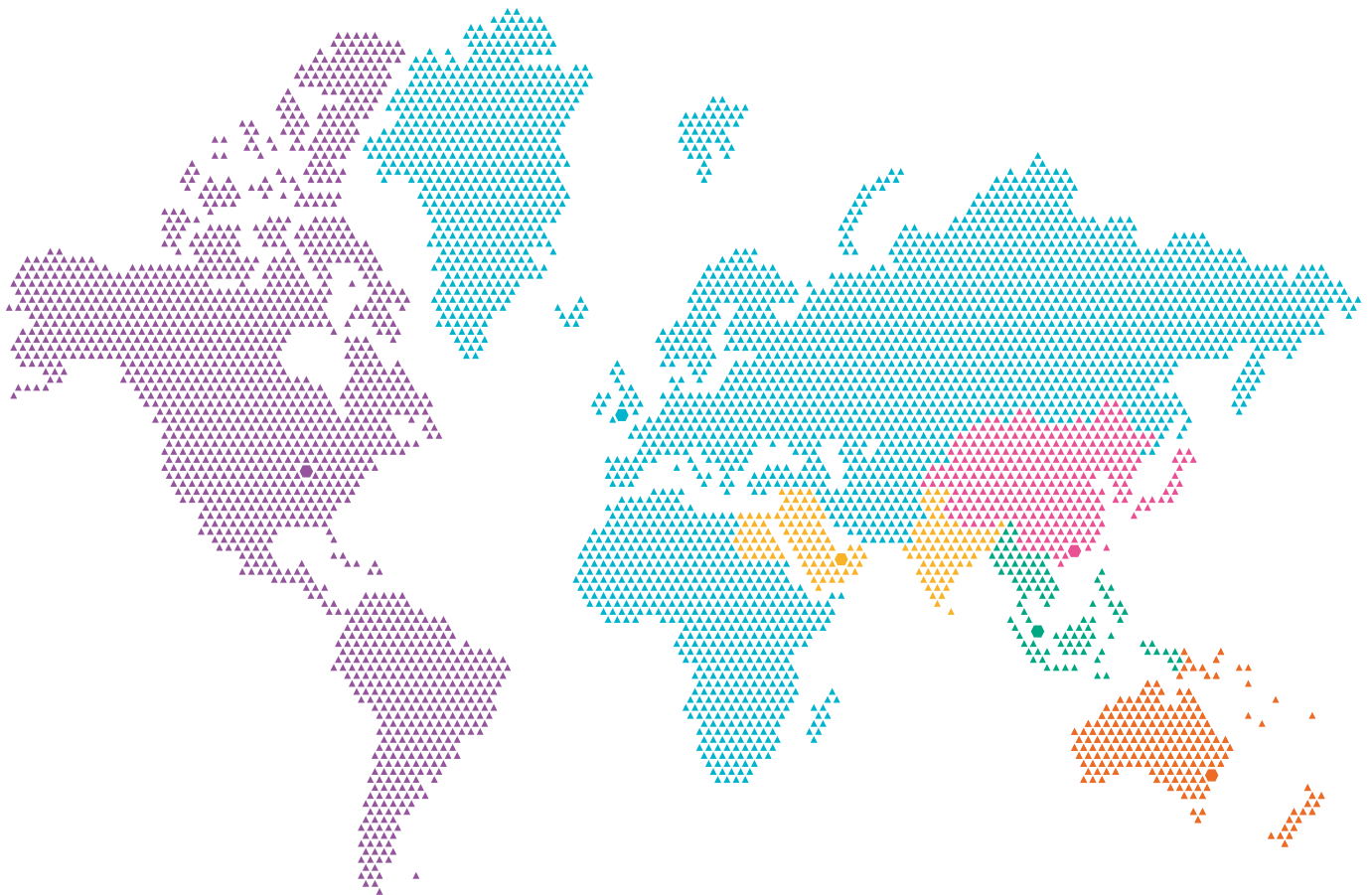

**The UK is home to our head office, manufacturing operation and dedicated R&D testing facility. Our UK & Europe head office supports operations around the world, delivering the best solutions locally to our customers across four continents.**

By keeping abreast of technical developments and changes to regulations and standards across the world, we deliver the highest levels of expertise and support.

 UNITED KINGDOM (HQ)

 AUSTRALIA

 SINGAPORE

 HONG KONG

 USA

 UAE

## ICONS EXPLAINED

The following icons are used throughout this brochure to give clear and easy recognition of a particular seal's function or possible application. Use of the icons does not necessarily indicate that test evidence exists. Refer to product system specification for relevant test evidence, or please check with the Lorient Technical team.



Fire protection



Smoke protection



Acoustic protection



Draught protection



Dust protection



Wheelchair friendly



Light protection



Thermal containment properties



Weather protection



[www.lorientuk.com/acousticsearch](http://www.lorientuk.com/acousticsearch)

Our Acoustic Search tool provides quick and easy access to a wide range of tested acoustic sealing systems on a variety of popular door constructions and configurations.

## PRODUCT ILLUSTRATIONS

All dimensions in this brochure are in millimetres.

## CONTENTS

01	Introduction
02	Sealing Doors Worldwide
04 – 07	Product Range
08	Life Threatening Forces
09	High Performance Sealing Systems
10	Building Regulations
11	Standards + Regulations
12 – 20	Compression Seals
21 – 31	Door Bottom Seals
32 – 39	Threshold Plates + Ramps
40 – 44	Brush Seals
45 – 47	Magnetic Seals
48 – 49	Meeting Stile Seals
50 – 60	Perimeter Seals
61 – 78	Drop Seals
79 – 84	Finger Guard / Speciality Seals
86	Finishes Information
87	Testing + Technical Services
88	Additional Information
90	CPD Seminars
92	Comprehensive Support

COMPRESSION SEALS

(PAGES 12–20)

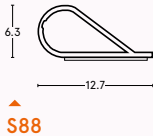

DOOR BOTTOM SEALS

(PAGES 21–31)

PERIMETER SEALS

(PAGES 50–60)

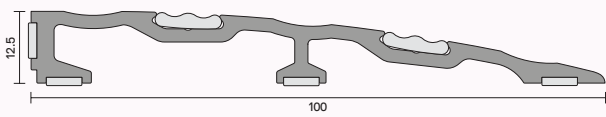

▲ AAS4551

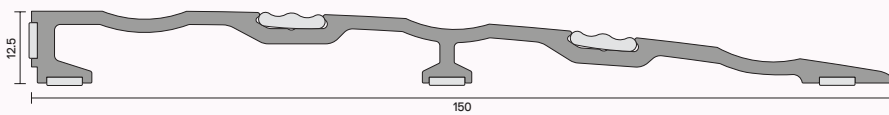

▲ AAS4552

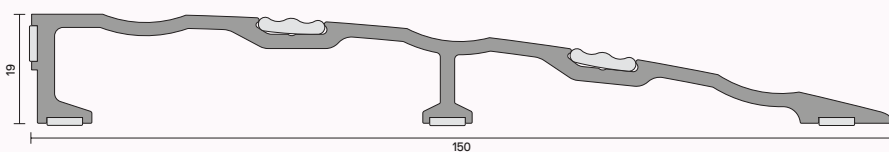

▲ AAS4553



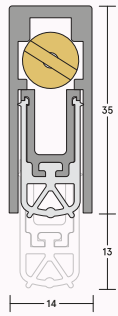

AAS8501 si

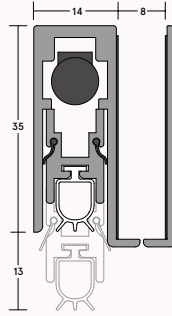

LAS8002G si  
Left + right handed  
variants available



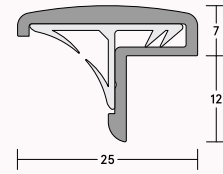

▲  
AAS7506

# LIFE THREATENING FORCES

On average 311 people are killed and 7,772 are injured\* in fires each year in the UK alone. Many of the casualties are attributable to breathing the toxic products of combustion from a remote fire.



England 2022/23. Source: Home Office 2024.

## Design Needs and Regulatory Requirements

When fire breaks out in a building the threat is twofold. Firstly, there is the fire itself and the hot smoke generated in the immediate vicinity. Secondly, there is cold smoke which will spread rapidly through the building, threatening people and property some distance from the fire. The Building Regulations take both these threats into account, and supporting documents give criteria for how they can be managed. Details can be found in Approved Document B (England & Wales), Technical Booklet E (N Ireland), and Technical Handbook Section 2 (Scotland).

The Regulations require large buildings to be divided into smaller fire and smoke resistant 'compartments', to reduce the risk of damage to the

building as a whole and also to save lives in the case of a fire. Building a fire resistant wall or floor to make a compartment is relatively simple. However, building design becomes much more complex when the compartments need to be linked in some way – essential to make the building usable. Every time an aperture is cut into one of the compartment boundaries (for example, to install a door in a fire resistant wall, or to pass ductwork through a wall or ceiling) the aperture must be filled with something that will preserve the fire and smoke integrity of the compartment.

That's the role of Lorient's products – to work with the surrounding elements of the building to preserve the integrity of the fire and smoke resistant compartments.

Our fire and smoke seals can be fitted into fire rated doors; our glazing products can be fitted into doors, screens or fire rated partitions; our air transfer grilles can be installed into doors, walls and ducts.

Fire and smoke protection products must be tested to prove their performance, and indeed, separate tests are required for fire and smoke. Our products are all extensively tested, and our test reports are freely available on request.



Call our Technical Services team

+44 (0) 1626 834252

[www.lorientuk.com](http://www.lorientuk.com)

# HIGH PERFORMANCE SEALING SYSTEMS

Today's architectural door assembly is heavily dependent on sealing systems for its performance; be that fire, smoke, acoustic or thermal containment. In choosing the right sealing solution, it's essential to make sure it's compatible with the door assembly.



# BUILDING REGULATIONS

The Building Regulations provide guidance as to the minimum building standards to be achieved. They reference the relevant British and European Standards defining the test requirements and performance of the fire door assembly or fire doorset.

There are several aspects of the Buildings Regulations that must be considered in conjunction with each other when specifying and installing fire resistant glazing systems. The regional variations of the Building Regulations:

<b>ENGLAND</b>	Approved Documents
<b>WALES</b>	Approved Documents
<b>SCOTLAND</b>	Technical Handbooks
<b>N.IRELAND</b>	Technical Booklets
<b>IRELAND</b>	Technical Booklets

	<b>ENGLAND</b>	<b>WALES</b>	<b>SCOTLAND</b>	<b>N.IRELAND</b>	<b>IRELAND</b>
<b>FIRE</b>	Approved Document B	Approved Document B	Technical Handbook 2	Technical Booklet E	Technical Guidance Document B
<b>ACOUSTICS</b>	Approved Document E	Approved Document E	Technical Handbook 5	Technical Booklet G	Technical Booklet G
<b>ACCESSIBILITY</b>	Approved Document M	Approved Document M	Technical Handbook 3	Technical Booklet R	Technical Booklet R
<b>VENTILATION</b>	Approved Document F	Approved Document F	Technical Handbook 3	Technical Booklet K	Technical Booklet K
<b>THERMAL</b>	Approved Document L	Approved Document L	Technical Handbook 6	Technical Booklet F	Technical Booklet F
<b>SECURITY</b>	Approved Document Q	Approved Document Q	-	-	-

# STANDARDS + REGULATIONS

The requirements for fire and smoke containment with regard to 'means of escape' are contained in the following standards:

## FIRE + SMOKE

STANDARD	TITLE
<a href="#">BS 476-20:1987</a>	Fire tests on building materials and structures. Method for determination of the fire resistance of elements of construction (general principles)
<a href="#">BS 476-22:1987</a>	Methods for determination of the fire resistance of non-loadbearing elements of construction
<a href="#">BS 476-31.1:1983</a>	Fire tests on building materials and structures. Methods for measuring smoke penetration through doorsets and shutter assemblies. Method of measurement under ambient temperature conditions
<a href="#">BS EN 1634-3:2004</a>	Fire resistance and smoke control tests for door and shutter assemblies, openable windows and elements of building hardware. Smoke control test for door and shutter assemblies
<a href="#">BS EN 1634-1:2014+A1:2018</a>	Fire resistance and smoke control tests for door and shutter assemblies, openable windows and elements of building hardware. Smoke control test for door and shutter assemblies
<a href="#">BS 8214:2016</a>	Code of practice for fire door assemblies
<a href="#">BS 9999:2017</a>	Code of practice for fire safety in the design, management and use of buildings

## ACOUSTIC

STANDARD	TITLE
<a href="#">BS EN ISO 10140-1:2021</a>	Acoustics. Laboratory measurement of sound insulation of building elements. Application rules for specific products
<a href="#">BS EN ISO 717-2:2020</a>	Acoustics. Rating of sound insulation in buildings and of building elements. Impact sound insulation elements of construction
<a href="#">ASTM E413-16</a>	Classification for Rating Sound Insulation

# COMPRESSION SEALS

A variety of durable, flexible and lightweight seals that are easy to fit to the perimeter of timber doors and window frames.

Compression seals are ideal for new build or retrofit applications.

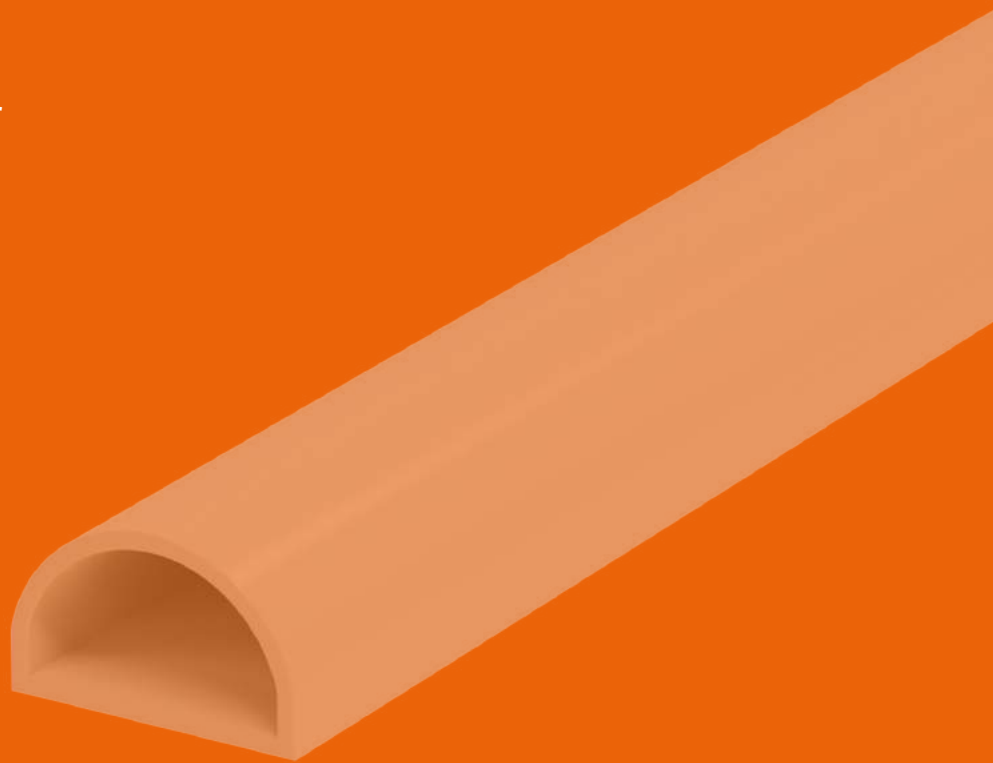

## COMPRESSION SEALS

# LAS1002 si, LAS1005 si & LAS1009 si

LIGHT DUTY **30dB**

Durable, kerf-fitting bulb seals of varying sizes for doors and window frames, which provide a compression seal. Lightweight and flexible. Quick and easy installation.



▲ LAS1005 si

▲ LAS1002 si

▲ LAS1009 si



▲ LAS1002 si

COMPRESSION SEALS

### SYSTEM SPECIFICATIONS

#### Test evidence

- ▶ Acoustic: BS EN ISO 10140-2: 2010 (up to Rw 30dB).

#### Performance

- ▶ Protects against sound, smoke, draught and light.

#### Location

- ▶ Head and jambs of single swing doors.

#### Use with

- ▶ Practically any threshold seal.

#### Min/max gap size

- ▶ LAS1005 - 3mm/4mm.
- ▶ LAS1002 - 4mm/6mm.
- ▶ LAS1009 - 5mm/8mm.

#### Seal material

- ▶ Flexible silicone rubber.

#### Standard lengths

- ▶ 100m reels.

#### Minimum order quantity

- ▶ 5,000m.

#### Fixing

- ▶ Interference fit into a kerf 2mm wide and minimum 4mm deep.

#### Colours

- ▶ Grey, dark brown or black. Other colours available on request.



## COMPRESSION SEALS

# LAS1020

## LIGHT DUTY

A superior quality, self-adhesive door and window frame strip, designed to protect your home against noise, drafts, insects and weather ingress. Flexible and lightweight, the 'P' shape design allows for easy installation and a secure fit, making it an ideal choice for a wide range of applications.



## COMPRESSION SEALS



LAS1020



LAS1020

### SYSTEM SPECIFICATIONS

#### Performance

- ▶ Protects against sound, weather, draught and light.

#### Location

- ▶ Mounted on the doorstep for single swing doors.

#### Use with

- ▶ Practically any threshold seal.

#### Min/max gap size

- ▶ 3mm/4mm.

#### Seal material

- ▶ Cellular rubber.

#### Standard lengths

- ▶ 5m rolls.

#### Minimum order quantity

- ▶ 85 x 5m rolls.

#### Fixing

- ▶ Self-adhesive tape.
- ▶ Note: contact surfaces must be clean, smooth and, if painted, well cured.

#### Colours

- ▶ White or brown.

## COMPRESSION SEALS

# LAS1025

## LIGHT DUTY

Superior quality, self-adhesive profile for door and window frames, which provide an acoustic compression seal. Lightweight and flexible. Quick and easy installation.



LAS1025



LAS1025

COMPRESSION SEALS

### SYSTEM SPECIFICATIONS

#### Performance

- ▶ Protects against sound, weather, draught and light.

#### Location

- ▶ Mounted on doorstep or can be recessed by up to 2mm on single swing doors.

#### Use with

- ▶ Practically any threshold seal.

#### Min/max gap size

- ▶ 3mm/4mm (rebated).
- ▶ 3mm/5.5mm (non-rebated).

#### Seal material

- ▶ Co-extruded elastomeric bulb with PVC spine.

#### Standard lengths

- ▶ 1m and 2.1m lengths.

#### Minimum order quantity

- ▶ 250 x 2.1m lengths.

#### Fixing

- ▶ Self-adhesive tape.
- ▶ Note: contact surfaces must be clean, smooth and, if painted, well cured.

#### Colours

- ▶ White or brown.

## COMPRESSION SEALS

# LAS1030

## LIGHT DUTY

A superior quality, self-adhesive door and window frame strip, designed to protect your home against noise, drafts, insects and weather ingress. Flexible and lightweight, the decorative 'W' shape is ideal for uneven gaps and surfaces.



## COMPRESSION SEALS



LAS1030

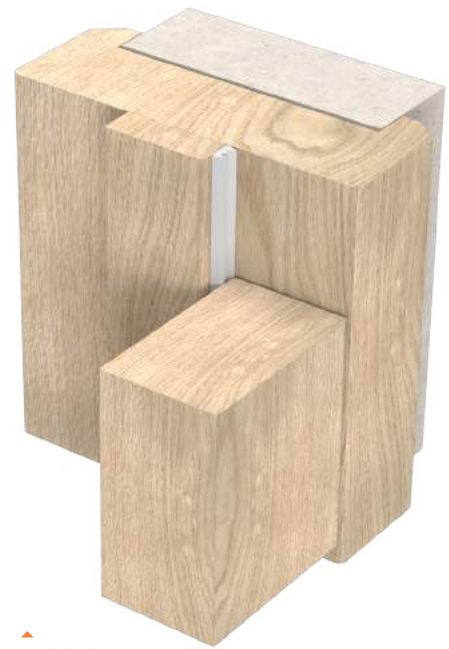

LAS1030

### SYSTEM SPECIFICATIONS

#### Performance

- ▶ Protects against sound, weather, draught and light.

#### Location

- ▶ Mounted on the doorstep for single swing doors.

#### Use with

- ▶ Practically any threshold seal.

#### Min/max gap size

- ▶ 2mm/3.5mm.

#### Seal material

- ▶ Cellular rubber.

#### Standard lengths

- ▶ 5m rolls.

#### Minimum order quantity

- ▶ 85 x 5m rolls.

#### Fixing

- ▶ Self-adhesive tape.
- ▶ Note: contact surfaces must be clean, smooth and, if painted, well cured.

#### Colours

- ▶ White or brown.

## COMPRESSION SEALS

# LAS1040

## LIGHT DUTY

A superior quality, self-adhesive door and window frame strip, designed to protect your home against noise, drafts, insects and weather ingress. Flexible and lightweight, the sleek shape of the LAS1040 is ideal for even gaps.



COMPRESSION SEALS



▲ LAS1040



▲ LAS1040

COMPRESSION SEALS

### SYSTEM SPECIFICATIONS

#### Performance

- ▶ Protects against sound, weather, draught and light.

#### Location

- ▶ Mounted on the doorstep for single swing doors.

#### Use with

- ▶ Practically any threshold seal.

#### Min/max gap size

- ▶ 2mm/3mm.

#### Seal material

- ▶ PVC foam.

#### Standard lengths

- ▶ 5m rolls.

#### Minimum order quantity

- ▶ 85 x 5m rolls.

#### Fixing

- ▶ Self-adhesive tape.
- ▶ Note: contact surfaces must be clean, smooth and, if painted, well cured.

#### Colours

- ▶ White or brown.

## COMPRESSION SEALS

# LAS1050

MEDIUM DUTY **45dB**

Durable, silicone compression seal for acoustic performance. Seal push fits quickly and easily into a 12mm wide x 12mm deep groove. No mechanical fixings/screws required.



COMPRESSION SEALS

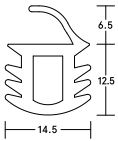

▲ LAS1050



### SYSTEM SPECIFICATIONS

#### Test evidence

- ▶ Acoustic: BS EN ISO 10140-2: 2010 (up to Rw 45dB).

#### Performance

- ▶ Protects against sound, draught and light.

#### Location

- ▶ Head and jambs of single swing doors.

#### Use with

- ▶ Practically any threshold seal.

#### Min/max gap size

- ▶ 2mm/4mm.

#### Seal material

- ▶ Flexible silicone rubber.

#### Standard lengths

- ▶ 100m reels.

#### Minimum order quantity

- ▶ 10,000m.

#### Fixing

- ▶ Interference fit into 12mm x 12mm preformed steel door frame rebate.

#### Colours

- ▶ Dark grey or black (non-UL).

#### Certification



(R27972)

## COMPRESSION SEALS

# LAS1060

## LIGHT DUTY

Durable, kerf-fitting bulb seal for doors and window frames, which provides a compression seal. Lightweight and flexible. Quick and easy installation.



COMPRESSION SEALS

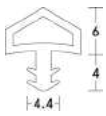

LAS1060



LAS1060

COMPRESSION SEALS

### SYSTEM SPECIFICATIONS

#### Performance

- ▶ Protects against sound, smoke, draught and light.

#### Location

- ▶ Head and jambs of single swing doors.

#### Use with

- ▶ Most Lorient architectural seals.

#### Min/max gap size

- ▶ 3mm/6mm.

#### Seal material

- ▶ Flexible elastomer rubber.

#### Standard lengths

- ▶ 40m reels.

#### Minimum order quantity

- ▶ 1200m.

#### Fixing

- ▶ Interference fit into a kerf 3mm wide and minimum 5mm deep.

#### Colours

- ▶ Dark brown or black.

## COMPRESSION SEALS

# LAS1606

## LIGHT DUTY

A light-weight bulb type buffer seal with a semi-rigid spine for kerf fitting. Suitable for external use and locations where moisture ingress may occur. Quick and easy installation.



LAS1606



### SYSTEM SPECIFICATIONS

#### Performance

- ▶ Protects against sound, weather, draught and light.

#### Location

- ▶ Head and jambs of single swing doors.

#### Use with

- ▶ Practically any threshold seal.

#### Min/max gap size

- ▶ 3mm/6mm.

#### Seal material

- ▶ Co-extruded elastomeric bulb with PVC spine.

#### Standard lengths

- ▶ 5m and 10m rolls.

#### Minimum order quantity

- ▶ 250 x 2.1m.

#### Fixing

- ▶ Interference fit into a kerf 2mm wide and minimum 6mm deep.

#### Colours

- ▶ White, grey, light brown or black.



## COMPRESSION SEALS

# S88

PEMKO BY LORIENT

The S88 is a versatile compression seal that is smoke and fire rated, meeting UBC7-2 positive pressure testing and Category G gasket for edge sealing systems for use with Category B doors. This lightweight seal is self-adhesive, making it easy to install, and it is available in a variety of colours.

### Key benefits

- ▶ High temperature silicone
- ▶ Self-extinguishing and non-toxic
- ▶ Longest-lasting commercial grade door seal
- ▶ Unaffected by sunlight, ozone and ultraviolet rays
- ▶ Impervious to fungus and mildew
- ▶ Excellent compression; door latches easily.

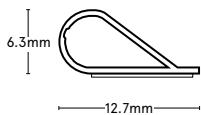

S88



S88

COMPRESSION SEALS

### SYSTEM SPECIFICATIONS

#### Product testing

- ▶ **GreenGuard GOLD Certification:** Tested to UL2818 and achieved GOLD certification for low V.O.C. content – [ulspot.com](http://ulspot.com) for certificate.
- ▶ **Air Infiltration:** Tested to ASTM E-283-04 (2012) for low air leakage allowance; allows no more than 0.3 cfm per square foot at 1.57 psf (75 Pa).
- ▶ **Acoustic:** Tested to ASTM E90 – 2009 in a single or in multiple sound seal configurations for sound attenuation in an opening.
- ▶ **Smoke:** Tested to UL 1784 and meets the requirements of NFPA 105-2013 for smoke leakage in an opening; allows no more than 3.0 cfm per square foot at 0.10" water column (about 75 Pa).
- ▶ **Fire:** Tested to UL10B Standard Fire Tests and UL10C Positive Pressure Fire

Tests of Door Assemblies.

- ▶ **BHMA Certified:** Tested for performance with regards to the requirements in: ANSI/BHMA A156.22 – Door Gasketing and Edge Seal Systems.

#### Location

- ▶ Side of frame.

#### Min/max gap size

- ▶ 1.5mm/6mm.

#### Seal material

- ▶ Silicone.

#### Standard lengths

- ▶ 155.45m roll.

#### Minimum order quantity

- ▶ 7000m (45 rolls).

#### Fixing

- ▶ Self-adhesive tape.
- ▶ Note: contact surfaces must be clean, smooth and, if painted, well cured.

#### Colours

- ▶ Black, white, dark brown or grey.

#### Certification



# DOOR BOTTOM SEALS



A range of versatile and hardwearing door bottom seals, that seal the gap between the bottom of the door and the floor.

They can be surface mounted or concealed in a rebated groove at the bottom of the door leaf. Use with a threshold plate for the optimum sealing solution.

## DOOR BOTTOM SEALS

# LAS3001 si

MEDIUM DUTY **32dB**

Medium duty door bottom seal with slide-in gasket ideal for acoustic and smoke containment.



DOOR BOTTOM SEALS

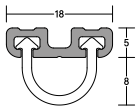

▲ LAS3001 si



▲ LAS3001 si (shown with LAS4001)

DOOR BOTTOM SEALS

### SYSTEM SPECIFICATIONS

#### Test evidence

- ▶ Acoustic: BS EN ISO 10140-2: 2010. Rw 32dB.

#### Performance

- ▶ Protects against sound, smoke, weather, draught, light and insects.

#### Location

- ▶ Single and double swing doors.

#### Use with

- ▶ Practically any threshold plate.

#### Min/max gap size

- ▶ 6mm/13mm.

#### Seal material

- ▶ Flexible silicone rubber.

#### Standard lengths

- ▶ 1m and 2.1m. Other lengths to special order.

#### Fixing

- ▶ Face-fixed, semi-rebated or fully rebated.
- ▶ Self-tapping wood screws are supplied (self-drilling and self-tapping screws for metal construction available on request).
- ▶ Fixing holes are pre-drilled. Once the aluminium carrier is fixed, the flexible silicone rubber gasket slides easily into place.
- ▶ Note: these seals cannot be adjusted once fitted.

#### Finish

- ▶ Silver anodised aluminium with grey silicone insert.

#### Certification



(R27972)

## DOOR BOTTOM SEALS

# LAS3002 si

MEDIUM DUTY **31dB**

Medium duty door bottom seal with slide-in gasket ideal for acoustic and smoke containment.



ID No.  
353

DOOR BOTTOM SEALS

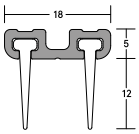

LAS3002 si



LAS3002 si (shown with LAS4001)

### SYSTEM SPECIFICATIONS

#### Test evidence

- ▶ Acoustic: BS EN ISO 10140-2: 2010. Rw 31dB.

#### Performance

- ▶ Protects against sound, smoke, weather, draught, light and insects.

#### Location

- ▶ Single and double swing doors.

#### Use with

- ▶ Practically any threshold plate.

#### Min/max gap size

- ▶ 10mm/17mm.

#### Seal material

- ▶ Flexible silicone rubber.

#### Standard lengths

- ▶ 1m and 2.1m. Other lengths to special order.

#### Fixing

- ▶ Face-fixed, semi-rebated or fully rebated.
- ▶ Self-tapping wood screws are supplied (self-drilling and self-tapping screws for metal construction available on request).
- ▶ Fixing holes are pre-drilled. Once the aluminium carrier is fixed, the flexible silicone rubber gasket slides easily into place.
- ▶ Note: these seals cannot be adjusted once fitted.

#### Finish

- ▶ Silver anodised aluminium with grey silicone insert.

#### Certification



(R27972)

## DOOR BOTTOM SEALS

# LAS3003 si

## MEDIUM DUTY

Medium duty door bottom seal with slide-in gasket ideal for acoustic and smoke containment.



DOOR BOTTOM SEALS

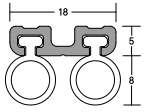

▲  
LAS3003 si



LAS3003 si (shown with LAS4001)

DOOR BOTTOM SEALS

### SYSTEM SPECIFICATIONS

#### Performance

- ▶ Protects against sound, smoke, weather, draught, light and insects.

#### Location

- ▶ Single and double swing doors.

#### Use with

- ▶ Practically any threshold plate.

#### Min/max gap size

- ▶ 7mm/13mm.

#### Seal material

- ▶ Flexible silicone rubber.

#### Standard lengths

- ▶ 1m and 2.1m. Other lengths to special order.

#### Fixing

- ▶ Face-fixed, semi-rebated or fully rebated.
- ▶ Self-tapping wood screws are supplied (self-drilling and self-tapping screws for metal construction available on request).
- ▶ Fixing holes are pre-drilled. Once the aluminium carrier is fixed, the flexible silicone rubber gasket slides easily into place.
- ▶ Note: these seals cannot be adjusted once fitted.

#### Finish

- ▶ Silver anodised aluminium with grey silicone insert.

## DOOR BOTTOM SEALS

# LAS3004 si

## HEAVY DUTY

A heavy duty, blade-type door bottom seal for easy face-fixed installations. Slimline aesthetic design with flexible cover strip to conceal fixings. It can easily accommodate a range of larger threshold gap sizes. Hard wearing and durable seal.

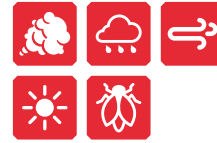

DOOR BOTTOM SEALS

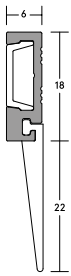

LAS3004 si



LAS3004 si (shown with LAS4010)

### SYSTEM SPECIFICATIONS

#### Performance

- ▶ Protects against smoke, weather, draught, light and insects when fitted with a suitable threshold seal.

#### Location

- ▶ Single and double leaf doors.
- ▶ Up and over garage doors.
- ▶ Roller shutter doors.

#### Use with

- ▶ Practically any threshold plate.

#### Min/max gap size

- ▶ 10mm/22mm.

#### Seal material

- ▶ Flexible silicone rubber.

#### Standard lengths

- ▶ 1m and 2.1m. Other lengths to special order.

#### Fixing

- ▶ Self-tapping wood screws are supplied (self-drilling and self-tapping screws for metal construction available on request).
- ▶ Fixing holes are pre-drilled and slotted to allow the seals to be adjusted and positioned accurately.

#### Finishes

- ▶ Silver anodised aluminium with grey cover strip and grey silicone rubber blade.
- ▶ Bronze anodised aluminium with black cover strip and black silicone rubber blade are subject to non-standard charges and additional lead times.

## DOOR BOTTOM SEALS

# LAS3007 si

### HEAVY DUTY

A heavy duty, multi-blade weather proof seal, which can be fitted without removing the door, and can be used with a choice of threshold plates. Concealed fixings, pre-drilled and slotted holes on LAS3007 si provide easy adjustment. Durable, anodised aesthetic finish.

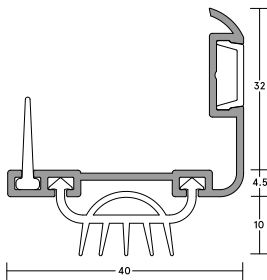
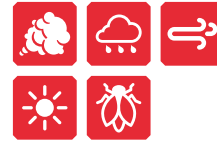

▲ LAS3007 si



▲ LAS3007 si (shown with LAS4010)

DOOR BOTTOM SEALS

### SYSTEM SPECIFICATIONS

#### Performance

- ▶ Protects against smoke, weather, draught, light and insects when fitted with a suitable threshold seal.

#### Location

- ▶ Single and double leaf doors.

#### Use with

- ▶ Practically any threshold plate, but ideally suited to LAS4015 si.

#### Min/max gap size

- ▶ 16mm/22mm.

#### Seal material

- ▶ Aluminium carrier with a flexible silicone rubber gasket.

#### Standard lengths

- ▶ 1m and 2.1m. Other lengths to special order.

#### Fixing

- ▶ Self-tapping wood screws are supplied (self-drilling and self-tapping screws for metal construction available on request).
- ▶ Fixing holes are pre-drilled and slotted to allow the seals to be adjusted and positioned accurately. A PVC cover strip to conceal fixings is supplied.

#### Finishes

- ▶ Silver anodised aluminium with grey cover strip and grey silicone rubber blade.
- ▶ Bronze anodised aluminium with black cover strip and black silicone rubber blade are subject to non-standard charges and additional lead times.

#### Certification



## DOOR BOTTOM SEALS

# LAS3008 si

## MEDIUM DUTY

A multi-blade, storm-proof seal combination consisting of the LAS3007 si door bottom seal and LAS4015 threshold plate. Durable, anodised aesthetic finish. It can be fitted without removing the door. Concealed fixings, pre-drilled and slotted holes on LAS3007 si for easy adjustment.

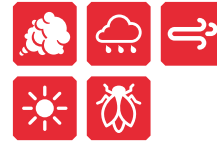

DOOR BOTTOM SEALS

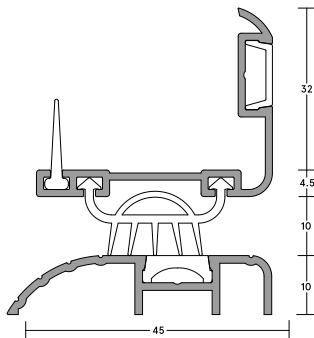

LAS3008 si



### SYSTEM SPECIFICATIONS

#### Performance

- ▶ Protects against smoke, weather, draught, light and insects when fitted with a suitable threshold seal.

#### Location

- ▶ Single swing doors.

#### Min/max gap size

- ▶ 26mm/32mm.

#### Seal material

- ▶ LAS3007 si – Aluminium carrier with a flexible silicone rubber gasket.
- ▶ LAS4015 – Aluminium with PVC cover strip.

#### Standard lengths

- ▶ 1m and 2.1m. Other lengths to special order.

#### Fixing

- ▶ LAS3007 si – Self-tapping wood screws are supplied (self-drilling and self-tapping screws for metal construction available on request). Fixing holes are predrilled and slotted to allow the seals to be adjusted and positioned accurately.
- ▶ A PVC cover strip to conceal fixings is supplied.
- ▶ LAS4015 – Fixing screws are supplied. PVC cover strip to conceal fixings is supplied.

#### Finishes

- ▶ Silver anodised aluminium with grey cover strip and grey silicone rubber blade.
- ▶ Bronze anodised aluminium with black cover strip and black silicone rubber blade are subject to non-standard charges and additional lead times.

## DOOR BOTTOM SEALS

# LAS3009 si

## MEDIUM DUTY

Medium duty door bottom seal with slide-in gaskets. Suitable for single and double swing doors, as well meeting stiles (one leaf only).

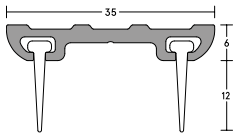

LAS3009 si



LAS3009 si (shown with LAS4002)

DOOR BOTTOM SEALS

### SYSTEM SPECIFICATIONS

#### Performance

- ▶ Protects against sound, smoke, weather, draught, light and insects when fitted with a suitable threshold seal.

#### Location

- ▶ Single and double swing doors.

#### Use with

- ▶ Practically any threshold plate.

#### Min/max gap size

- ▶ 16mm/22mm.

#### Seal material

- ▶ Flexible silicone rubber.

#### Standard lengths

- ▶ 1m and 2.1m. Other lengths to special order.

#### Fixing

- ▶ Self-tapping wood screws are supplied (self-drilling and self-tapping screws for metal construction available on request).
- ▶ Fixing holes are pre-drilled. Once the aluminium carrier is fixed, the rubber gasket slides easily into place.
- ▶ Note: these seals cannot be adjusted once fitted.

#### Finishes

- ▶ Silver anodised aluminium with grey silicone rubber blades.
- ▶ Bronze anodised aluminium with black silicone rubber blades are subject to non-standard charges and additional lead times.

#### Specification

## DOOR BOTTOM SEALS

# LAS3010 si

## HEAVY DUTY

A heavy duty, multi-blade weather protective seal, which can be fitted without removing the door, and can be used with a choice of threshold plates. Concealed fixings, pre-drilled and slotted holes on LAS3010 si provide easy adjustment. Durable, anodised aesthetic finish.

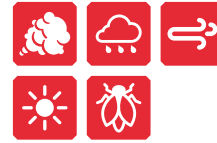

DOOR BOTTOM SEALS

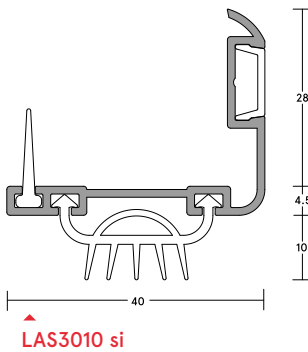

### SYSTEM SPECIFICATIONS

#### Performance

- ▶ Protects against smoke, weather, draught, light and insects when fitted with a suitable threshold seal.

#### Location

- ▶ Single and double leaf doors.

#### Use with

- ▶ Practically any threshold plate, but ideally suited to the LAS4016.

#### Min/max gap size

- ▶ 16mm - 20mm.

#### Seal material

- ▶ Aluminium carrier with a flexible silicone rubber gasket.

#### Standard lengths

- ▶ 1m and 2.1m.

#### Fixing

- ▶ Self-tapping wood screws are supplied (self-drilling and self-tapping screws for metal construction available on request).
- ▶ Fixing holes are pre-drilled and slotted to allow the seals to be adjusted and positioned accurately. A PVC cover strip to conceal fixings is supplied

#### Finishes

- ▶ Silver anodised aluminium with grey cover strip and grey silicone rubber gasket.

## DOOR BOTTOM SEALS

# LAS3012 si

## MEDIUM DUTY

A multi-blade weather protective door bottom seal and threshold plate combination, consisting of the LAS3010 si door bottom seal and the LAS4016 threshold plate. Ideal for protecting your home from the elements. A decorative cover strip on the door bottom seal conceals fixings for an aesthetic finish.

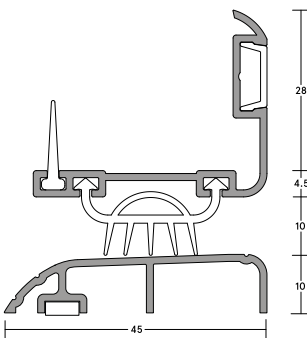
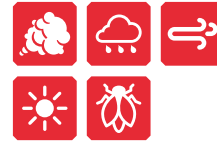

LAS3012 si



LAS3012 si

DOOR BOTTOM SEALS

### SYSTEM SPECIFICATIONS

#### Performance

- ▶ Protects against smoke, sound, weather draught, light and insects.

#### Location

- ▶ Single swing doors.

#### Min/max gap size

- ▶ 26mm - 30mm.

#### Seal material

- ▶ Aluminium carrier with a flexible silicone rubber gasket.

#### Standard lengths

- ▶ 1m and 2.1m.

#### Fixing

- ▶ Self-tapping wood screws are supplied (self-drilling and self-tapping screws for metal construction available on request). Fixing holes are predrilled and slotted to allow the seals to be adjusted and positioned accurately.
- ▶ A PVC cover strip to conceal fixings is supplied.

#### Finish

- ▶ LAS3010 si: Silver anodised aluminium with grey cover strip and grey silicone rubber gasket.
- ▶ LAS4016: Silver anodised aluminium.

# THRESHOLD PLATES + RAMPS

Hardwearing aluminium and stainless steel threshold plates and ramps that are affixed to the sill beneath the door. Threshold plates provide a firm and effective sealing surface for threshold seals to rest against, while also covering the join between different flooring materials.

Threshold ramps feature a gentle sloping gradient to accommodate differences in floor heights.

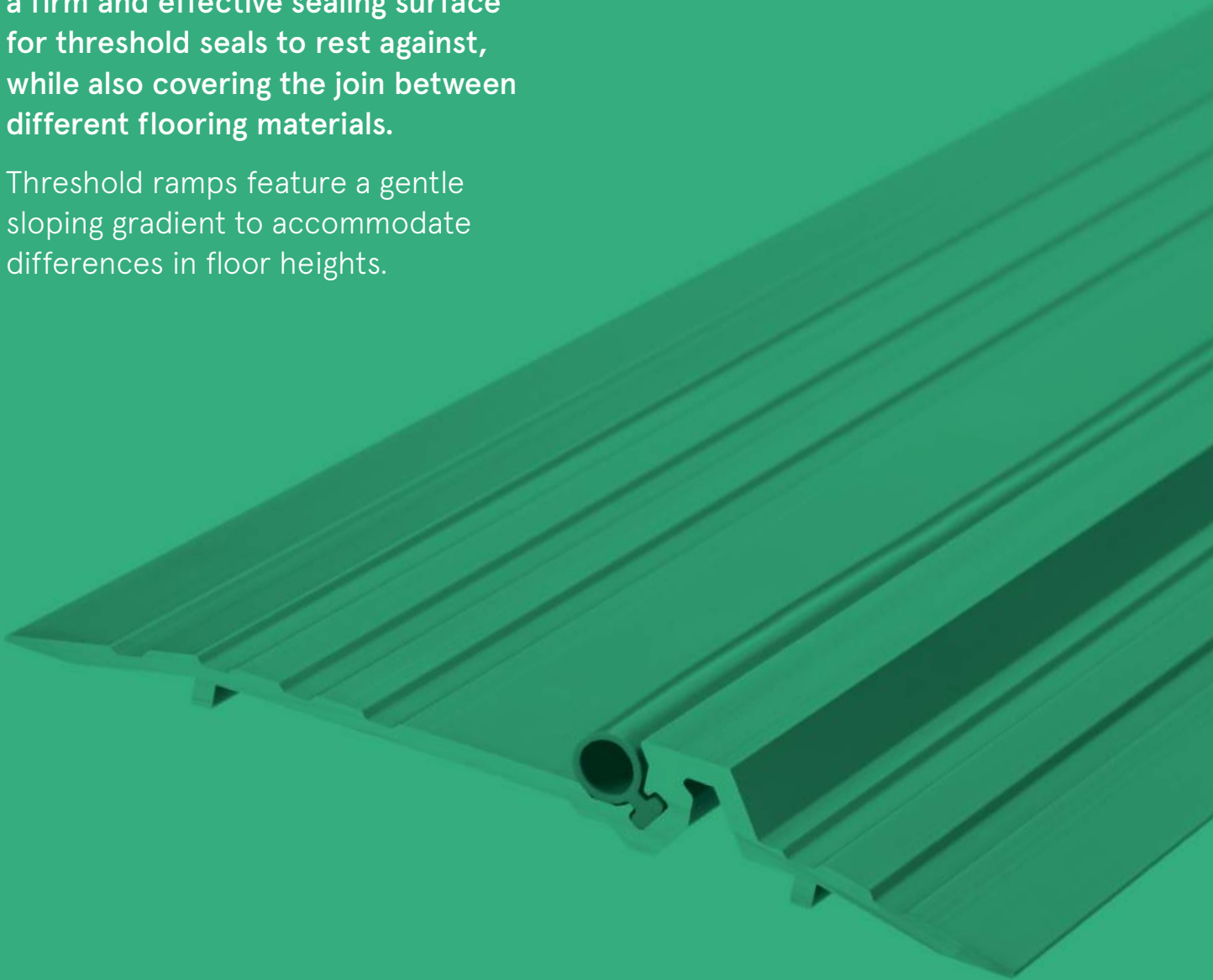

# LAS4001 & LAS4002

## MEDIUM DUTY

Medium duty, gently curved low-profile aluminium threshold plates. These plates can increase the effectiveness of threshold seals by creating a firmer gasket contact. Durable anodised aesthetic finish. Quick and easy installation.

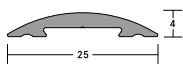

LAS4001

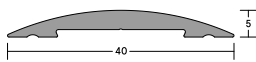

LAS4002



LAS4001

### SYSTEM SPECIFICATIONS

#### Performance

- ▶ Protects against sound, smoke, weather, draught, light and insects when fitted with a suitable threshold seal.
- ▶ Provides an even surface underneath the door; suitable for wheeled traffic.

#### Location

- ▶ Single and double swing doors.

#### Use with

- ▶ Practically any drop or door bottom seal.

#### Material

- ▶ Aluminium.

#### Standard lengths

- ▶ 1m and 2.1m. Other lengths to special order.

#### Fixing

- ▶ Fixing screws are supplied.

#### Finishes

- ▶ Silver anodised aluminium as standard.
- ▶ Bronze anodised aluminium and other powder-coated colour finishes are subject to non-standard charges and additional lead times.

#### Certification

## THRESHOLD PLATES + RAMPS

# LAS4010, LAS4011, LAS4012 & LAS4013

## MEDIUM DUTY

Medium duty, low profile aluminium threshold plates, only 6mm high. Ideal for wheeled traffic. These plates can increase the effectiveness of threshold seals by creating a firmer gasket contact. Durable anodised aesthetic finish. Quick and easy installation.



THRESHOLD PLATES + RAMPS

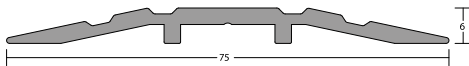

LAS4010

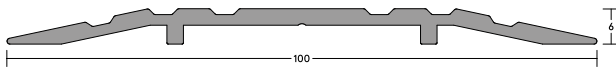

LAS4011

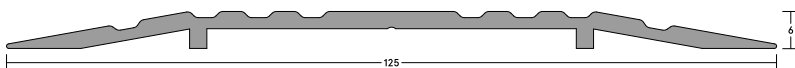

LAS4012



LAS4013



LAS4010

### SYSTEM SPECIFICATIONS

#### Performance

- ▶ Protects against sound, smoke, weather, draught, light and insects when fitted with a suitable threshold seal.
- ▶ Provides an even surface underneath the door; suitable for wheeled traffic.

#### Location

- ▶ Single and double swing doors.

#### Use with

- ▶ Practically any drop or door bottom seal.

#### Material

- ▶ Aluminium.

#### Standard lengths

- ▶ 1m and 2.1m. Other lengths to special order.

#### Fixing

- ▶ Fixing screws are supplied.

#### Finishes

- ▶ Silver anodised aluminium as standard.
- ▶ Bronze anodised aluminium and other powder-coated colour finishes are subject to non-standard charges and additional lead times.

#### Certification



# LAS4014 si

HEAVY DUTY **42dB**

Heavy duty, aluminium, stepped threshold plate featuring high performance silicone compression seal, which helps to prevent rain, draught, light and noise penetration. Can increase the effectiveness of threshold seals by creating a firmer gasket contact. Durable anodised aesthetic finish.

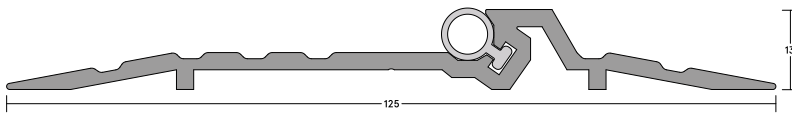

LAS4014 si



## SYSTEM SPECIFICATIONS

### Test evidence

- ▶ Smoke: BS 476-31.1: 1983 at ambient temperature.
- ▶ Acoustic: BS EN ISO 10140-2: 2010 (up to Rw 42dB).
- ▶ Durability: 100,000 cycles.

### Performance

- ▶ Meets smoke requirement: BS 9999: 2017.
- ▶ Protects against sound, smoke, weather, draught, light and insects.
- ▶ Suitable for use of fire rated steel doorsets.
- ▶ Provides an even surface underneath the door; suitable for wheeled traffic.

### Location

- ▶ Single and double leaf outward opening doors.

### Use with

- ▶ Practically any drop or door bottom seal.

### Material

- ▶ Aluminium and silicone gasket.

### Standard lengths

- ▶ 1m and 2.1m. Other lengths to special order.

### Fixing

- ▶ Fixing screws are supplied.

### Finishes

- ▶ Silver anodised aluminium with grey silicone rubber gasket as standard.
- ▶ Bronze anodised aluminium with black silicone rubber gasket are subject to non-standard charges and additional lead times.

- ▶ Other powder-coated colour finishes (non-standard - charges and lead times apply).

### Certification

# LAS4015

## HEAVY DUTY

Heavy duty, aluminium threshold plate suitable for outward opening doors to prevent rain, draught and light. Can increase the effectiveness of threshold seals by creating a firmer gasket contact. Durable anodised aesthetic finish.

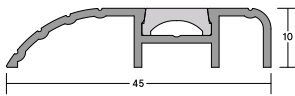

LAS4015

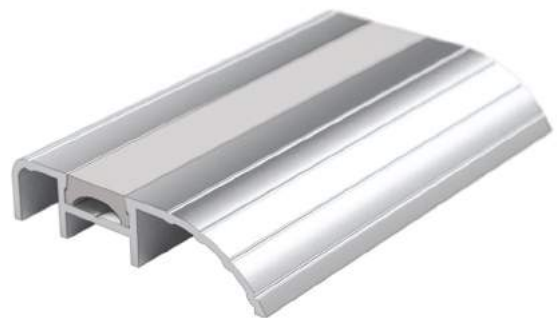

### SYSTEM SPECIFICATIONS

#### Performance

- ▶ Protects against sound, smoke, weather, draught, light and insects when fitted with a suitable threshold seal.
- ▶ Provides an even surface underneath the door; suitable for wheeled traffic.

#### Location

- ▶ Single and double leaf outward opening doors.

#### Use with

- ▶ Practically any drop or door bottom seal.

#### Material

- ▶ Aluminium and PVC cover strip.

#### Standard lengths

- ▶ 1m and 2.1m. Other lengths to special order.

#### Fixing

- ▶ Fixing screws are supplied.

#### Finishes

- ▶ Silver anodised aluminium as standard.
- ▶ Bronze anodised aluminium and other powder-coated colour finishes are subject to non-standard charges and additional lead times.

#### Certification

# LAS4016

## HEAVY DUTY

This heavy-duty aluminium threshold plate is designed to keep your home dry and free of water damage. The profile ensures that rain and other water is quickly and efficiently diverted away from your door, while the foot prevents water from migrating underneath.

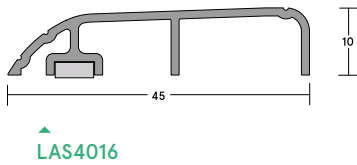

### SYSTEM SPECIFICATION

#### Performance

- ▶ Protects against weather, sound, smoke, draught, light and insects when fitted with a suitable threshold seal.
- ▶ Provides an even surface underneath the door; suitable for wheeled traffic.

#### Location

- ▶ Single and double leaf doors.

#### Use with

- ▶ Practically any drop or door bottom seal, but ideally suited to the LAS3010 si.

#### Material

- ▶ Aluminium.

#### Standard lengths

- ▶ 1m and 2.1m.

#### Fixing

- ▶ LAS4016 is provided pre-drilled with fixing screws supplied.

#### Finishes

- ▶ Silver anodised aluminium.

# LAS4100

## MEDIUM DUTY

Durable, medium duty aluminium threshold plate, 10mm high. It can increase the effectiveness of threshold seals by creating a firmer gasket contact. Quick and easy installation.

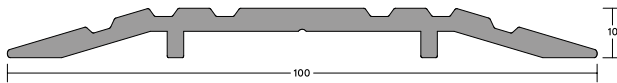

LAS4100



### SYSTEM SPECIFICATIONS

#### Performance

- ▶ Protects against sound, smoke, weather, draught, light and insects when fitted with a suitable threshold seal.
- ▶ Provides an even surface underneath the door; suitable for wheeled traffic.

#### Location

- ▶ Single and double swing doors.

#### Use with

- ▶ Practically any drop or door bottom seal.

#### Material

- ▶ Aluminium.

#### Standard lengths

- ▶ 1m and 2.1m. Other lengths to special order.

#### Fixing

- ▶ Fixing screws are supplied.

#### Finishes

- ▶ Silver anodised aluminium as standard.
- ▶ Bronze anodised aluminium and other powder-coated colour finishes are subject to non-standard charges and additional lead times.

# AAS4551

## MEDIUM DUTY

For use in buildings where wheelchairs and trolleys are used, or to compensate for uneven floors. Reversible tread strips provide greater traction. Unique 'scoops' further enhance grip for foot or wheeled traffic.

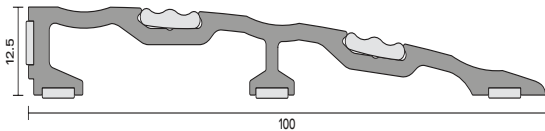

▲ AAS4551



▲ AAS4551

### SYSTEM SPECIFICATIONS

#### Performance

- ▶ Protects against sound, smoke, weather, draught, light and insects when fitted with a suitable threshold seal.
- ▶ Provides an even surface underneath the door; suitable for wheeled traffic.

#### Location

- ▶ Single and double swing doors.

#### Use with

- ▶ Practically any drop or door bottom seal.

#### Material

- ▶ Aluminium with two flexible thread strips.

#### Standard lengths

- ▶ 1m and 2.1m. Other lengths to special order.

#### Fixing

- ▶ Pre-drilled and countersunk
- ▶ Fixing screws are supplied.
- ▶ Tread strips supplied and push-fit into plate to conceal fixings

#### Finishes

- ▶ Silver anodised aluminium with grey tread strips as standard.
- ▶ Bronze anodised aluminium with black tread strips and other powder-coated colour finishes are subject to non-standard charges and additional lead times.

#### Certification

# AAS4552

## MEDIUM DUTY

For use in buildings where wheelchairs and trolleys are used, or to compensate for uneven floors. Reversible tread strips provide greater traction. Unique 'scoops' further enhance grip for foot or wheeled traffic.

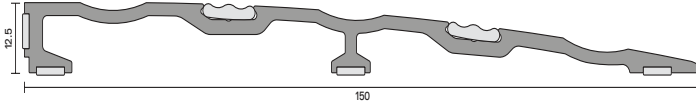

▲ AAS4552



▲ AAS4552

### SYSTEM SPECIFICATIONS

#### Performance

- ▶ Protects against sound, smoke, weather, draught, light and insects when fitted with a suitable threshold seal.
- ▶ Provides an even surface underneath the door; suitable for wheeled traffic.

#### Location

- ▶ Single and double swing doors.

#### Use with

- ▶ Practically any drop or door bottom seal.

#### Material

- ▶ Aluminium with two flexible thread strips.

#### Standard lengths

- ▶ 1m and 2.1m. Other lengths to special order.

#### Fixing

- ▶ Pre-drilled and countersunk
- ▶ Fixing screws are supplied.
- ▶ Tread strips supplied and push-fit into plate to conceal fixings

#### Finishes

- ▶ Silver anodised aluminium with grey tread strips as standard.
- ▶ Bronze anodised aluminium with black tread strips and other powder-coated colour finishes are subject to non-standard charges and additional lead times.

#### Certification

# AAS4553

MEDIUM DUTY

For use in buildings where wheelchairs and trolleys are used, or to compensate for uneven floors. Reversible tread strips provide greater traction. Unique 'scoops' further enhance grip for foot or wheeled traffic.

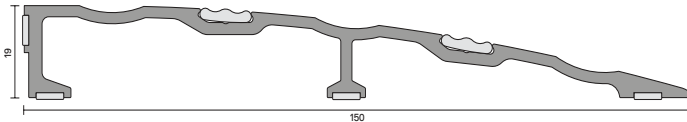

▲ AAS4553



▲ AAS4553

## SYSTEM SPECIFICATIONS

### Performance

- ▶ Protects against sound, smoke, weather, draught, light and insects when fitted with a suitable threshold seal.
- ▶ Provides an even surface underneath the door; suitable for wheeled traffic.

### Location

- ▶ Single and double swing doors.

### Use with

- ▶ Practically any drop or door bottom seal.

### Material

- ▶ Aluminium with two flexible thread strips.

### Standard lengths

- ▶ 1m and 2.1m. Other lengths to special order.

### Fixing

- ▶ Pre-drilled and countersunk
- ▶ Fixing screws are supplied.
- ▶ Tread strips supplied and push-fit into plate to conceal fixings

### Finishes

- ▶ Silver anodised aluminium with grey tread strips as standard.
- ▶ Bronze anodised aluminium with black tread strips and other powder-coated colour finishes are subject to non-standard charges and additional lead times.

### Certification

# BRUSH SEALS



A series of hard-wearing sweep action brush seals suitable for numerous installations and door types; including single and double swing, revolving, sliding, up and over and roller shutter doors.

The independent filaments of the brush conform to irregular surfaces for a more complete seal.



## BRUSH SEALS

# LAS5010, LAS5015, LAS5020, LAS5025 & LAS5030

## MEDIUM DUTY

Hard wearing, medium duty brush seals, suitable for various installations and door types. Nylon brush seals with aluminium carriers. Flexible and durable. Quick and easy installation.

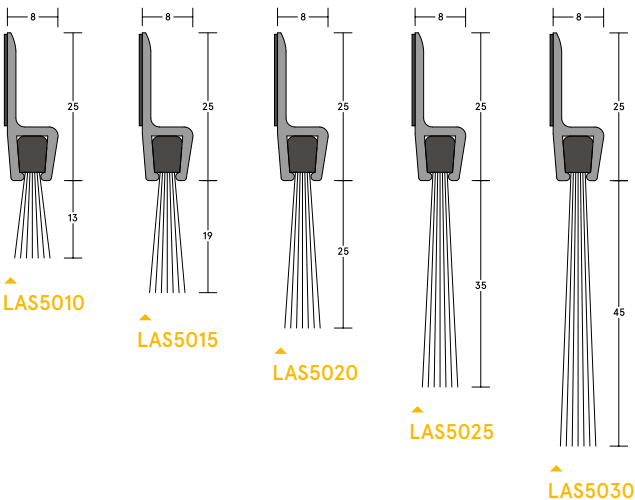

BRUSH SEALS

## SYSTEM SPECIFICATIONS

### Performance

- ▶ Meets smoke requirement: BS 9999: 2017.
- ▶ Protects against smoke, weather, draught and light.

### Location

- ▶ Head, jambs, threshold and meeting stiles of single and double swing doors and sliding doors.
- ▶ Head, jambs and threshold of revolving doors, up and over doors, and roller shutter doors.

### Use with

- ▶ Any threshold plate.

### Seal material

- ▶ Polypropylene brush filaments, UV stabilised.

### Min/max gap size

- ▶ LAS5010: 10mm/13mm.
- ▶ LAS5015: 13mm/19mm.
- ▶ LAS5020: 19mm/25mm.
- ▶ LAS5025: 25mm/35mm.
- ▶ LAS5030: 35mm/45mm.

### Standard lengths

- ▶ 1m and 2.1m. Other lengths to special order.

### Fixing

- ▶ Heavy duty self-adhesive tape.
- ▶ Screw fixing recommended: screws not supplied.

### Finishes

- ▶ Silver anodised aluminium with black brush filaments as standard.
- ▶ Bronze anodised aluminium with black brush filaments are subject to non-standard charges and additional lead times.

## BRUSH SEALS

# LAS5035, LAS5040, LAS5045, LAS5050 & LAS5055

## HEAVY DUTY

Hard wearing, heavy duty brush seals, suitable for numerous installations and door types. Nylon brush seals with aluminium carriers. Flexible and durable. Quick and easy installation.



BRUSH SEALS

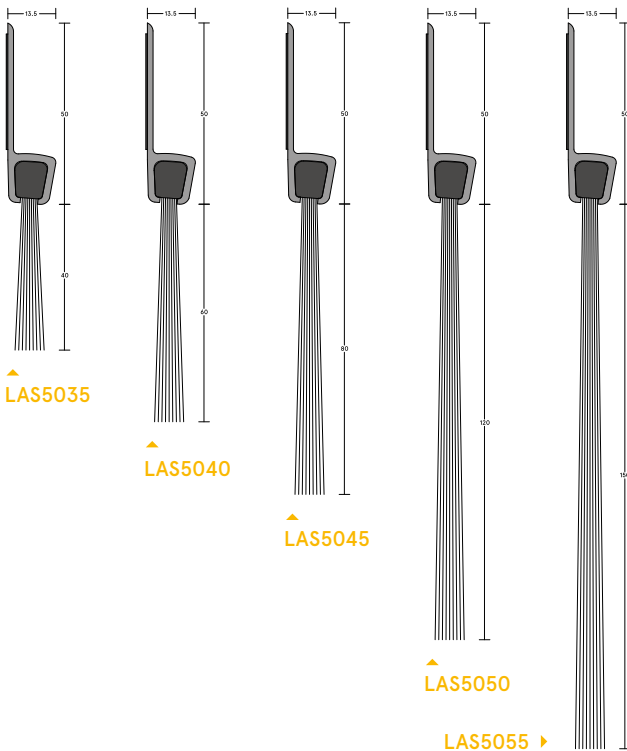

## SYSTEM SPECIFICATIONS

### Performance

- ▶ Meets smoke requirement: BS 9999: 2017.
- ▶ Protects against smoke, weather, draught and light.

### Location

- ▶ Head, jambs, threshold and meeting stiles of single and double swing doors, and sliding doors.
- ▶ Head, jambs and threshold of revolving doors, up and over doors, and roller shutter doors.

### Use with

- ▶ Any threshold plate.

### Seal material

- ▶ Polypropylene brush filaments, UV stabilised.

### Min/max gap size

- ▶ LAS5035: 20mm/40mm.
- ▶ LAS5040: 40mm/60mm.
- ▶ LAS5045: 60mm/80mm.
- ▶ LAS5050: 80mm/120mm.
- ▶ LAS5055: 120mm/150mm.

### Standard lengths

- ▶ 1m and 2.1m.
- Other lengths to special order.

### Fixing

- ▶ Heavy duty self-adhesive tape.
- ▶ Screw fixing recommended: screws not supplied.

### Finishes

- ▶ Silver anodised aluminium with black brush filaments as standard.
- ▶ Bronze anodised aluminium with black brush filaments are subject to non-standard charges and additional lead times.

## BRUSH SEALS

# LAS5060, LAS5065 & LAS5070

## MEDIUM DUTY

Hard wearing, medium duty brush seals, with 90° aluminium carriers. Flexible and durable. Quick and easy installation.

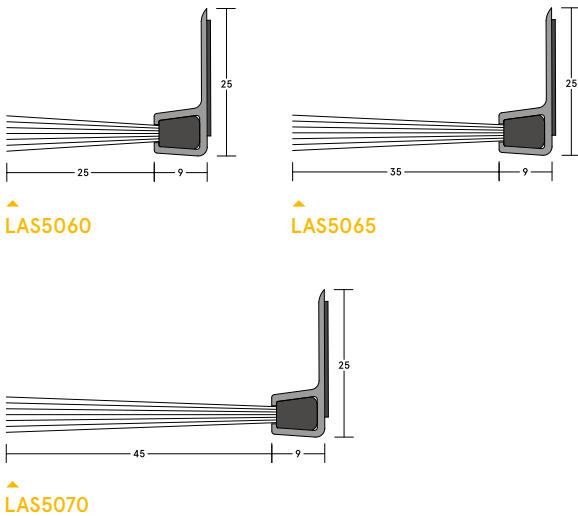

BRUSH SEALS

### SYSTEM SPECIFICATIONS

#### Performance

- ▶ Protects against smoke, weather, draught and light.

#### Location

- ▶ Sliding doors.

#### Min/max gap size

- ▶ LAS5060: 24mm/30mm.
- ▶ LAS5065: 32mm/40mm.
- ▶ LAS5070: 39mm/50mm.

#### Seal material

- ▶ Polypropylene brush filaments, UV stabilised.

#### Standard lengths

- ▶ 1m and 2.1m. Other lengths to special order.

#### Fixing

- ▶ Heavy duty self-adhesive tape.
- ▶ Screw fixing recommended: screws not supplied.

#### Finishes

- ▶ Silver anodised aluminium with black brush filaments as standard.
- ▶ Bronze anodised aluminium with black brush filaments are subject to non-standard charges and additional lead times.

## BRUSH SEALS

# LAS5075, LAS5080 & LAS5085

## MEDIUM DUTY

Hard wearing, medium duty brush seals with 45° aluminium carriers. Flexible and durable. Quick and easy installation.



BRUSH SEALS

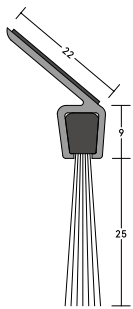

LAS5075

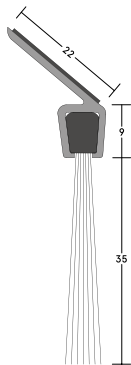

LAS5080

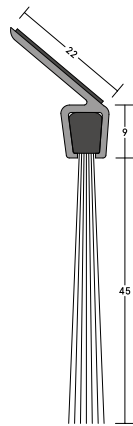

LAS5085



LAS5075

### SYSTEM SPECIFICATIONS

#### Performance

- ▶ Protects against smoke, weather, draught and light.

#### Location

- ▶ A variety of industrial door applications requiring angled brushes.

#### Min/max gap size

- ▶ LAS5075: 19mm/25mm.
- ▶ LAS5080: 25mm/35mm.
- ▶ LAS5085: 35mm/45mm.

#### Seal material

- ▶ Polypropylene brush filaments, UV stabilised.

#### Standard lengths

- ▶ 1m and 2.1m. Other lengths to special order.

#### Fixing

- ▶ Heavy duty self-adhesive tape.
- ▶ Screw fixing recommended: screws not supplied.

#### Finishes

- ▶ Silver anodised aluminium with black brush filaments as standard.
- ▶ Bronze anodised aluminium with black brush filaments are subject to non-standard charges and additional lead times.

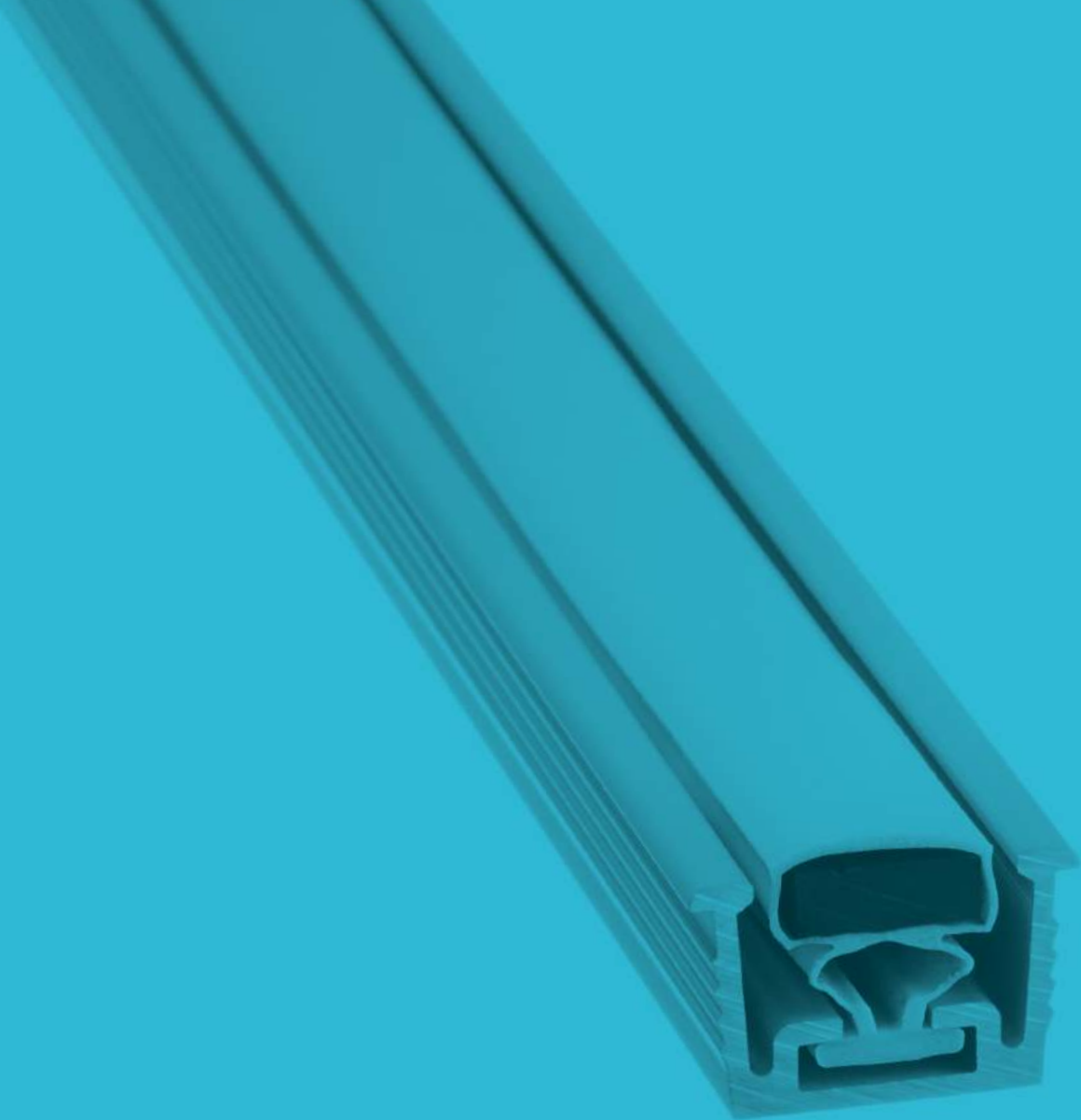

# MAGNETIC SEALS

Magnetic seals for use on both steel and timber doors. These seals provide a tight seal for door jambs and may also be used as a stop.

These seals have sufficient magnetic strength that latches may not be required.

## MAGNETIC SEALS

# LAS6001

MEDIUM DUTY **40dB**

A refrigeration-type vinyl magnetic strip in anodised aluminium housing. The strip holds the door closed so latches are not always required. Concealed fixings, pre-drilled and slotted holes for easy adjustment. Easily installed without removing the door and it can be used as a stop. Option to be supplied with magnetic keeper strip.



MAGNETIC SEALS

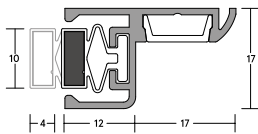

LAS6001



LAS6011



### SYSTEM SPECIFICATIONS

#### Test evidence

- ▶ Acoustic: BS EN ISO 10140-2: 2010 (up to Rw 40dB).

#### Performance

- ▶ Protects against sound, smoke, draught and light.

#### Location

- ▶ Head and jambs of single swing steel clad doors and timber doors (use with LAS6011).

#### Seal material

- ▶ LAS6001 – flexible insert with magnetic core.
- ▶ LAS6011 – PVC sleeve with magnetic insert.

#### Standard lengths

- ▶ 1m and 2.1m. Other lengths and single doorset packs consisting of 1 x 1m and 2 x 2.1m available to special order.

#### Fixing

- ▶ Self-tapping wood screws are supplied (self-drilling and self-tapping screws for metal construction available on request).
- ▶ Fixing holes are pre-drilled and slotted to allow the seals to be adjusted and positioned accurately. A PVC cover strip to conceal fixings is supplied.
- ▶ LAS6011 has an aggressive self-adhesive backing for fixing into a groove on timber doors.
- ▶ Note: order LAS6011 magnetic keeper strip for use with timber doors. Supplied with self-adhesive backing as standard.

#### Finishes

- ▶ LAS6001 – silver anodised aluminium with grey insert as standard.
- ▶ LAS6001 – bronze anodised aluminium with black insert are subject to non-standard charges and additional lead times.
- ▶ LAS6011 – white, black, grey, light brown, dark brown or PVC sleeve. Other colours to special order subject to MOQs.

## MAGNETIC SEALS

# LAS6002

## MEDIUM DUTY

A medium duty magnetic seal that has sufficient magnetic strength to hold the door closed so latches are not always required.

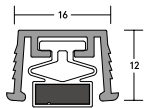

▲ LAS6002



MAGNETIC SEALS

### SYSTEM SPECIFICATIONS

#### Performance

- ▶ Protects against smoke, draught and light.

#### Location

- ▶ Rebated meeting stiles of double leaf doors.
- ▶ Sliding doors.

#### Seal material

- ▶ Grey flexible insert with black magnetic core.

#### Standard lengths

- ▶ 2.1m. Other lengths to special order.

#### Fixing

- ▶ The aluminium profile is toothed to lock into a 16mm x 12mm groove.
- ▶ The magnetic seals are also 'locked' into prevent creeping.

#### Finish

- ▶ Silver anodised aluminium with grey insert as standard. Black insert available to special order.
- ▶ Note: not suitable where centre latching is required.

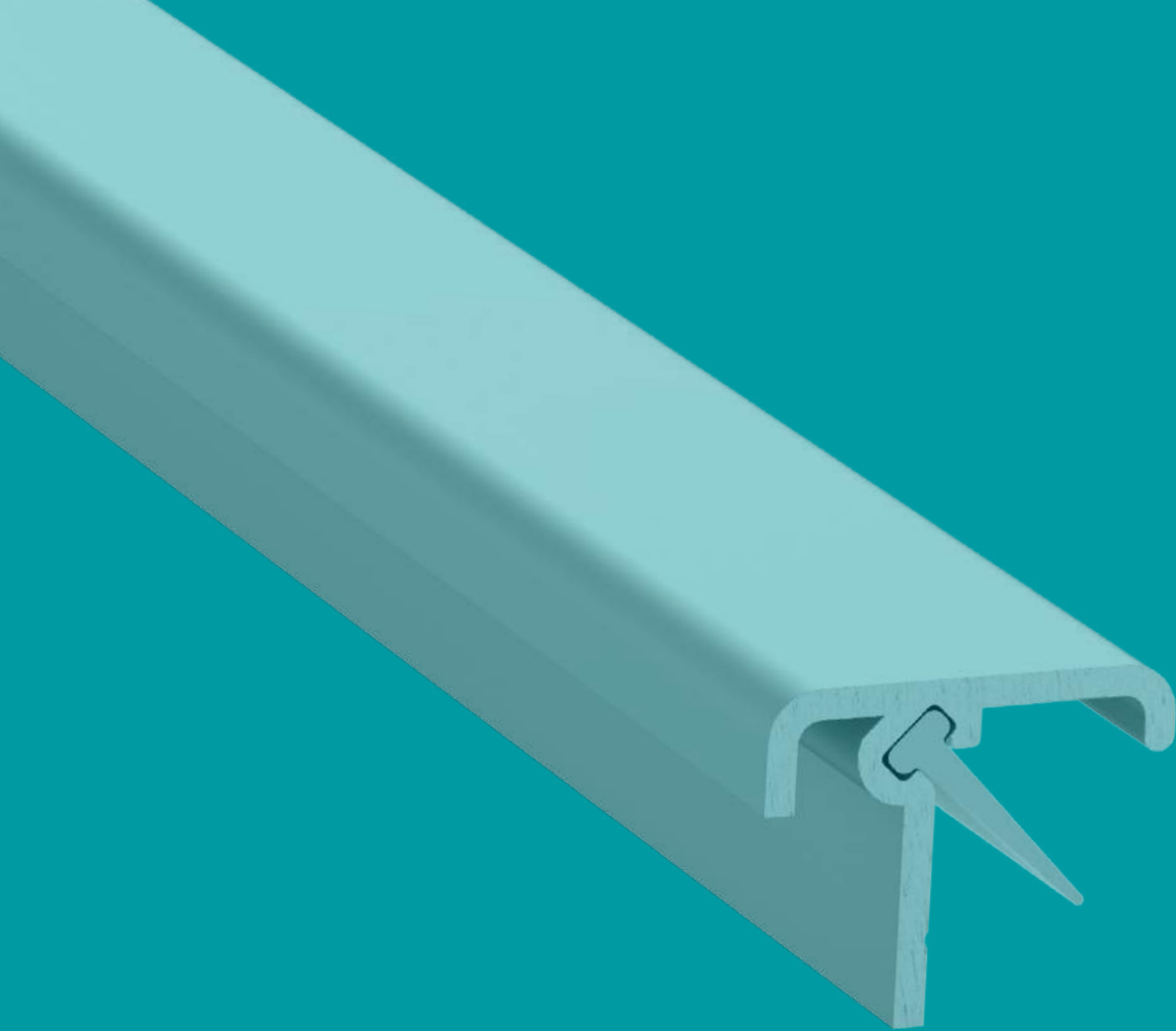

# MEETING STILE SEALS

Meeting stile seals for use on both plain or rebated doors. These seals provide a seal between single swing, double doors.

Designed to protect against smoke, sound, light and draught containment.



## MEETING STILE SEAL

# LAS7006 si

### FACE-FIXED

A high performance seal designed for use on plain or rebated meeting stiles. With proven medium temperature smoke performance, it also makes a positive contribution to light, sound, and draught containment. The leg can be cut out to make way for locks and latches.

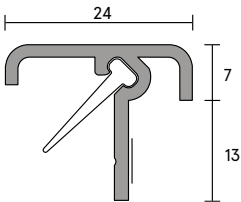

▲ LAS7006 si



▲ LAS7006 si

MEETING STILE SEALS

### SYSTEM SPECIFICATIONS

#### Test evidence

- ▶ Smoke: BS EN 1634-3:2004 at ambient and medium temperature; effective smoke seal up to 200°C.

#### Performance

- ▶ Protects against smoke, sound draught, dust, light and weather.

#### Location

- ▶ Meeting stiles of single swing doors.
- ▶ Double doors – where only one door leaf is in use or a door selector is fitted.

#### Use with

- ▶ Practically any perimeter seal.

#### Seal material

- ▶ Aluminium carrier with flexible silicone blade.

#### Standard length

- ▶ 2.1m.

#### Fixing

- ▶ Secure with heavy duty self-adhesive tape.
- ▶ Screw into place (fixings supplied).
- ▶ Note: A door selector should be considered unless one leaf is intended to be fixed.

#### Finishes

- ▶ Silver anodised aluminium with grey silicone rubber gasket as standard.
- ▶ Other finishes available to special order (non-standard – charges and lead times apply).

## MEETING STILE SEAL

# ASS7506

## FACE-FIXED

A robust seal designed for use on plain or rebated meeting stiles. With proven acoustic performance it is also suitable for smoke, light, and draught containment. The leg can be cut out to make way for locks and latches.



MEETING STILE SEALS

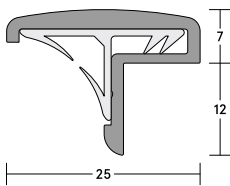

▲ ASS7506



▲ ASS7506

### SYSTEM SPECIFICATIONS

#### Test evidence

- ▶ Smoke: BS EN 1634-3: 2004 & BS 476-31.1: 1983 at ambient temperature.
- ▶ Acoustic: BS EN ISO 10140-2: 2010.
- ▶ Weighted Sound Reduction Index: 33dB (AAS7506 & AAS8501 on a standard architectural door).
- ▶ Durability: 100,000 cycles.

#### Performance

- ▶ Protects against smoke, sound draught, dust, light and weather.

#### Location

- ▶ Meeting stiles of single swing doors.
- ▶ Double doors – where only one door leaf is in use or a door selector is fitted.

#### Use with

- ▶ Practically any perimeter seal.

#### Seal material

- ▶ Anodised aluminium carrier with co-extruded elastomeric insert with flexible curved fins.

#### Standard length

- ▶ 1m & 2.1m.

#### Fixing

- ▶ Fixing holes pre-punched and countersunk.
- ▶ Wood screws supplied – please request self-tappers.
- ▶ Using self-adhesive tape to position aluminium carrier while fixing, push-fit Batwing® seal into place.
- ▶ Note: A door selector should be considered unless one leaf is intended to be fixed.

#### Finishes

- ▶ Silver anodised aluminium with grey insert as standard. Other finishes available to special order (non-standard – charges and lead times apply).
- ▶ Black, white, dark brown, light brown, clear, red, silver and cream Batwing® inserts are subject to MOQs.

#### Certification



MEETING STILE SEALS

# PERIMETER SEALS



A comprehensive range of  
slimline perimeter seals  
for installation around the  
head, jambs and meeting  
stiles of doors.

These seals are designed to  
accommodate a wide range of  
gap sizes and applications, and  
are ideally teamed with drop  
seals or door bottom seals.

# LAS1206 Single Batwing®

MEDIUM DUTY

The LAS1206 single Batwing® is a smoke and acoustic perimeter seal. Its 10mm high, single fin design creates a tight seal while minimising the force required to open and close the door. Made from a flexible elastomeric material, the fin springs back into shape after every use, ensuring long-lasting performance. Easy to install with minimal disruption, the LAS1206 is suitable for both single and double leaf doors on the head and jambs.

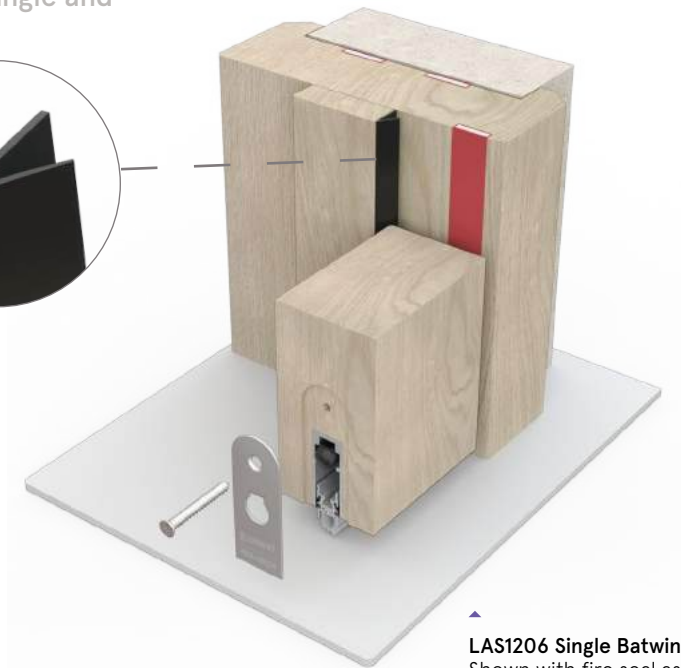
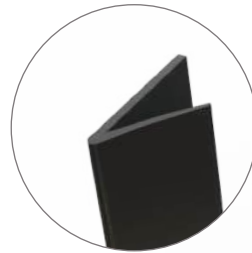

▲  
**LAS1206 Single Batwing®**  
Shown with fire seal as  
referenced in CNA/F14171  
(also shown with LAS8001 si)

## SYSTEM SPECIFICATIONS

### Test evidence

- ▶ Smoke: BS 476-31.1: 1983 at ambient temperature.
- ▶ Acoustic: BS EN ISO 10140-2: 2010 (up to Rw 34dB).
- ▶ Durability: 100,000 cycles.

### Performance

- ▶ Meets smoke requirement: BS 9999:2017.
- ▶ Protects against sound, smoke, draught and light.

### Features

- ▶ Seal surface and fins contain anti-microbial additives.

### Location

- ▶ Head and jambs of single and double leaf doors.

### Use with

- ▶ Any fire seals or architectural seals.

### Min/max gap size

- ▶ 3mm/4mm.

### Seal material

- ▶ Co-extruded rigid back PVC with flexible fins.

### Standard lengths

- ▶ 1m and 2.1m.
- ▶ Single doorset pack consisting of 1 x 1m and 2 x 2.1m.
- ▶ Other lengths to special order.

### Fixing

- ▶ Heavy duty self-adhesive backing tape.

### Colours

- ▶ Black, white, dark brown, light brown and grey as standard.
- ▶ Silver, cream, red and clear are subject to MOQs.
- ▶ Note: clear Batwing® will not prevent light penetration.

### Certification

# LAS1007 Single Batwing®

MEDIUM DUTY

PERIMETER SEALS

The LAS1007 single Batwing® is a smoke and acoustic perimeter seal for fire-rated steel-based door assemblies / doorsets. Its 14mm high, single fin design creates a tight seal while minimising the force required to open and close the door. Made from a flexible elastomeric material, the fin springs back into shape after every use, ensuring long-lasting performance. Easy to install with minimal disruption, the LAS1007 is suitable for both single and double leaf doors on the head and jambs.



LAS1007  
Single  
Batwing®

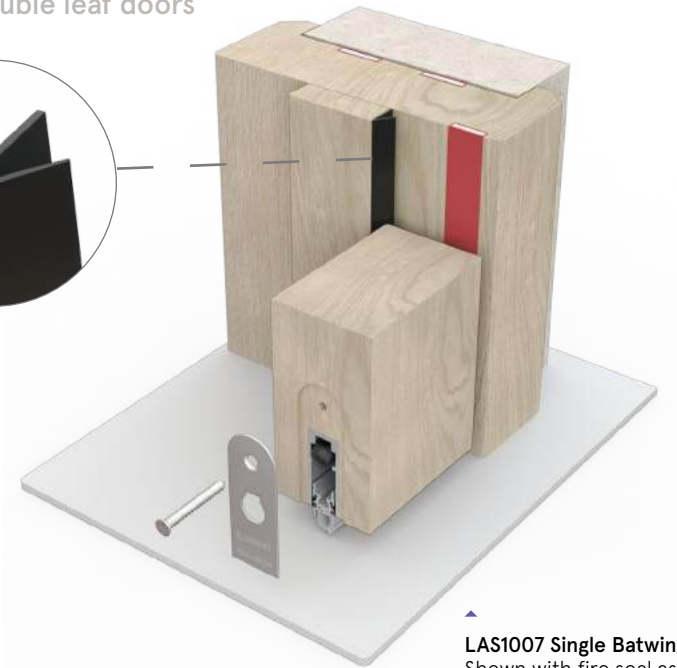
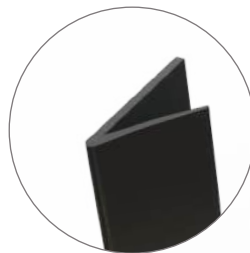

LAS1007 Single Batwing®  
Shown with fire seal as  
referenced in CNA/F14171  
(also shown with LAS8001 si)

## SYSTEM SPECIFICATIONS

### Test evidence

- ▶ Smoke: BS 476-31.1: 1983 at ambient temperature; BS EN 1634-3:2004 at ambient temperature.
- ▶ Acoustic: BS EN ISO 10140-2: 2010 (up to Rw 34dB).
- ▶ Durability: 100,000 cycles.

### Performance

- ▶ Meets smoke requirement: BS 9999:2017.
- ▶ Protects against sound, smoke, draught and light.
- ▶ Suitable for use of fire rated steel doorsets.

### Features

- ▶ Seal surface and fins contain anti-microbial additives.

### Location

- ▶ Head and jambs of single and double leaf doors,

### Use with

- ▶ Any fire seals or architectural seals.

### Min/max gap size

- ▶ 3mm/4mm.

### Seal material

- ▶ Co-extruded rigid back PVC with flexible fins.

### Standard lengths

- ▶ 1m and 2.1m.
- ▶ Single doorset pack consisting of 1 x 1m and 2 x 2.1m.
- ▶ Other lengths to special order.

### Fixing

- ▶ Heavy duty self-adhesive backing tape.

### Colours

- ▶ Black, white, dark brown, light brown and grey as standard.
- ▶ Silver, cream, red and clear are subject to MOQs.
- ▶ Note: clear Batwing® will not prevent light penetration.

### Certification

# LAS1010, LAS1212, LAS1015 Batwing®

## MEDIUM DUTY

The LAS1010, LAS1212 & LAS1015 Batwing® smoke and acoustic seals are designed for easy installation with a simple peel and stick feature. The double fin design provides a reliable barrier against smoke and sound while minimising resistance when opening and closing the door.

Made from a flexible elastomeric material, the Batwing® seals boasts long-lasting performance as the fins spring back to their original shape after each use. Suitable for both single and double leaf doors on the head and jambs, this Batwing® seal installs with minimal disruption, offering a simple solution for smoke and acoustic containment.

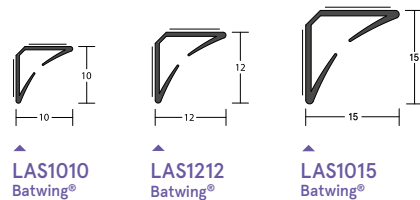

▲ **LAS1212 Batwing®**  
Shown with fire seal as referenced in CNA/F14171 (also shown with LAS8001 si)

### SYSTEM SPECIFICATIONS

#### Test evidence

- ▶ Smoke: BS 476-31.1: 1983 at ambient temperature; BS EN 1634-3:2004 at ambient and medium temperature (LAS1212); effective smoke seal up to 200°C.
- ▶ Acoustic: BS EN ISO 10140-2: 2010 (up to Rw 44dB).
- ▶ Durability: minimum of 100,000 cycles.

#### Performance

- ▶ Meets smoke requirement: BS 9999:2017.
- ▶ Protects against sound, smoke, draught and light.

#### Features

- ▶ Seal surface and fins contain anti-microbial additives.

#### Location

- ▶ Head and jambs of single and double leaf doors.

#### Use with

- ▶ Any fire seals or architectural seals.

#### Min/max gap size

- ▶ 3mm/4mm.

#### Seal material

- ▶ Co-extruded rigid back PVC with flexible fins.

#### Standard lengths

- ▶ 1m and 2.1m.
- ▶ Single doorset pack consisting of 1 x 1m and 2 x 2.1m.
- ▶ Other lengths to special order.

#### Fixing

- ▶ Heavy duty self-adhesive backing tape.

#### Colours

- ▶ Black, white, dark brown, light brown and grey as standard.
- ▶ Silver, cream, red and clear are subject to MOQs.
- ▶ Note: clear Batwing® will not prevent light penetration.

#### Certification

LAS1212



# LAS1206K Batwing® on-a-stick

MEDIUM DUTY **32dB**

The LAS1206K Single Batwing®-on-a-stick is a smoke and acoustic seal designed for easy installation with its innovative kerf fixing feature. The single fin design provides a reliable barrier against smoke and sound while minimising resistance when opening and closing the door. Made from a flexible elastomeric material, the LAS1206K boasts long-lasting performance as the fin springs back to its original shape after each use.



PERIMETER SEALERS SEALS

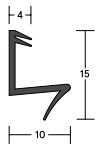

▲ LAS1206K  
Batwing®  
on-a-stick



▲ LAS1206K Batwing®

## SYSTEM SPECIFICATIONS

### Test evidence

- ▶ Smoke: BS 476-31.1: 1983 at ambient temperature.
- ▶ Acoustic: BS EN ISO 10140-2: 2010 (up to Rw 37dB).
- ▶ Durability: minimum of 100,000 cycles.

### Performance

- ▶ Meets smoke requirement: BS 9999: 2017.
- ▶ Protects against sound, smoke, draught and light.

### Location

- ▶ Head and jambs of single and double leaf doors.

### Use with

- ▶ Practically any drop seal.

### Min/max gap size

- ▶ 3mm/4mm.

### Seal material

- ▶ Co-extruded rigid back PVC with flexible fins.

### Standard lengths

- ▶ 1m and 2.1m.
- ▶ Single doorset pack consisting of 1 x 1m and 2 x 2.1m.
- ▶ Other lengths to special order.

### Fixing

- ▶ Route a groove, and push-fit into place.
- ▶ Groove size is 11mm x 3mm – suitable for internal or external use.

### Colours

- ▶ Black, white, dark brown, light brown and grey as standard.
- ▶ Silver, cream, red and clear are subject to MOQs.
- ▶ Note: clear Batwing® will not prevent light penetration.

### Certifications



(R27972)



# LAS1212K Batwing® on-a-stick

MEDIUM DUTY **37dB**

The LAS1212K Batwing®-on-a-stick is a smoke and acoustic seal designed for easy installation with its innovative kerf fixing feature. The 12mm profile, with a double fin design provides a reliable barrier against smoke and sound while minimising resistance when opening and closing the door.

Made from a flexible elastomeric material, the LAS1212K boasts long-lasting performance as the fins spring back to their original shape after each use. Suitable for both single and double leaf doors on the head and jambs, this Batwing® seal installs with minimal disruption, offering a simple solution for smoke and acoustic containment.



PERIMETER SEALS

PERIMETER SEALS

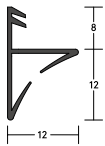

LAS1212K  
Batwing®  
on-a-stick



LAS1212K Batwing®

## SYSTEM SPECIFICATIONS

### Test evidence

- ▶ Smoke: BS 476-31.1: 1983 at ambient temperature.
- ▶ Acoustic: BS EN ISO 10140-2: 2010 (up to Rw 37dB).
- ▶ Durability: minimum of 100,000 cycles.

### Performance

- ▶ Meets smoke requirement: BS 9999: 2017.
- ▶ Protects against sound, smoke, draught and light.

### Location

- ▶ Head and jambs of single and double leaf doors.

### Use with

- ▶ Practically any drop seal.

### Min/max gap size

- ▶ 3mm/4mm.

### Seal material

- ▶ Co-extruded rigid back PVC with flexible fins.

### Standard lengths

- ▶ 1m and 2.1m.
- ▶ Single doorset pack consisting of 1 x 1m and 2 x 2.1m.
- ▶ Other lengths to special order.

### Fixing

- ▶ Route a groove, and push-fit into place.
- ▶ Groove size is 9mm x 3mm – suitable for internal or external use.

### Colours

- ▶ Black, white, dark brown, light brown and grey as standard.
- ▶ Silver, cream, red and clear are subject to MOQs.
- ▶ Note: clear Batwing® will not prevent light penetration.

### Certifications



(R27972)

certifire

(CF5179)

## PERIMETER SEALS

# LAS1011 & LAS1016 Firtree™

## MEDIUM DUTY

Highly effective acoustic seals, which also provide additional cold smoke protection around the perimeter of fire rated doors. Flexible and durable. They can be fitted with minimal disruption to the door assembly.



PERIMETER SEALS



▲ LAS1011  
Firtree™



▲ LAS1016  
Firtree™ 6mm

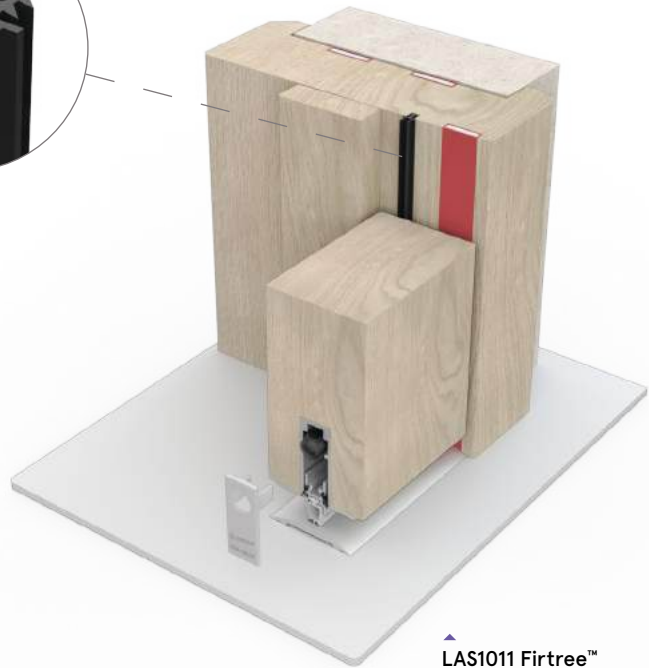
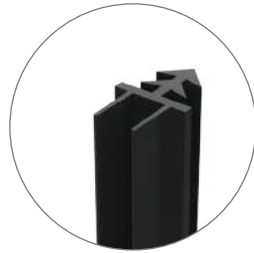

▲ LAS1011 Firtree™

Shown with fire seal as referenced in CNA/F14171 (shown with LAS8005 si + LAS4002)

### SYSTEM SPECIFICATIONS

#### Test evidence

- ▶ Smoke: BS 476-31.1: 1983 at ambient temperature.
- ▶ Acoustic: BS EN ISO 10140-2: 2010 (up to Rw 40dB).
- ▶ Durability: minimum of 100,000 cycles.

#### Performance

- ▶ Meets smoke requirement: BS 9999:2017.
- ▶ Protects against sound, smoke, draught and light.

#### Location

- ▶ Head and jambs of single and double leaf doors. May also be used at the threshold when combined with a threshold plate.

#### Use with

- ▶ Any fire seals or architectural seals.

#### Min/max gap size

- ▶ 3mm/4mm (LAS1011).
- ▶ 4mm/6mm (LAS1016).

#### Seal material

- ▶ Co-extruded rigid back PVC with flexible fins.

#### Standard lengths

- ▶ 1m and 2.1m. Other lengths to special order.

#### Fixing

- ▶ Groove size is 3mm x 4mm.

#### Colours

- ▶ Black or white as standard.
- ▶ Dark brown and light brown are subject to MOQs.

#### Certification

# LAS7001 si

MEDIUM DUTY **33dB**

Slimline, aluminium, perimeter seal featuring a silicone gasket ideal for acoustic and smoke containment. Designed to be fitted to existing door stops. A neat cover plate conceals fixing screws. Easily installed without removing the door.

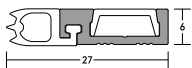

▲ LAS7001 si



▲ LAS7001 si

PERIMETER SEALS

## SYSTEM SPECIFICATIONS

### Test evidence

- ▶ Smoke: BS EN 1634-3:2004 at ambient and medium temperature; effective smoke seal up to 200°C.
- ▶ Acoustic: BS EN ISO 10140-2: 2010 si (up to Rw 33dB).
- ▶ Durability: 100,000 cycles.

### Performance

- ▶ Meets smoke requirement: BS 9999: 2017.
- ▶ Protects against sound, smoke, weather, draught and light.

### Location

- ▶ Head and jambs of single swing doors.

### Use with

- ▶ Practically any threshold seal.

### Seal material

- ▶ Flexible silicone rubber.

### Standard lengths

- ▶ 1m and 2.1m. Single doorset pack consisting of 1 x 1m and 2 x 2.1m. Other lengths to special order.

### Fixing

- ▶ Self-tapping wood screws are supplied (self-drilling and self-tapping screws for metal construction available on request).
- ▶ Fixing holes are pre-drilled and slotted to allow the seals to be adjusted and positioned accurately. A PVC cover strip to conceal fixings is supplied.

### Finishes

- ▶ Silver anodised aluminium with grey cover strip and grey silicone rubber gasket as standard.
- ▶ Bronze anodised aluminium with black cover strip and black silicone rubber gasket or other powder-coated colour finishes are subject to non-standard charges and additional lead times.

### Certification

## PERIMETER SEALS

# LAS7002 si

MEDIUM DUTY **34dB**

Slimline, aluminium, perimeter seal featuring a silicone gasket ideal for acoustic and smoke containment. Designed to be fitted to existing door stops. A neat cover plate conceals fixing screws. Easily installed without removing the door.



PERIMETER SEALS

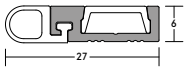

▲ LAS7002 si



▲ LAS7002 si

## SYSTEM SPECIFICATIONS

### Test evidence

- ▶ Smoke: BS 476-31.1: 1983 at ambient temperature.
- ▶ Acoustic: BS EN ISO 10140-2: 2010. si (up to Rw 34dB).
- ▶ Durability: 100,000 cycles.

### Performance

- ▶ Meets smoke requirement: BS 9999: 2017.
- ▶ Protects against sound, smoke, weather, draught and light.

### Location

- ▶ Head and jambs of single swing doors.

### Use with

- ▶ Practically any threshold seal.

### Seal material

- ▶ Flexible silicone rubber.

### Standard lengths

- ▶ 1m and 2.1m. Single doorset pack consisting of 1 x 1m and 2 x 2.1m. Other lengths to special order.

### Fixing

- ▶ Self-tapping wood screws are supplied (self-drilling and self-tapping screws for metal construction available on request).
- ▶ Fixing holes are pre-drilled and slotted to allow the seals to be adjusted and positioned accurately. A PVC cover strip to conceal fixings is supplied.

### Finishes

- ▶ Silver anodised aluminium with grey cover strip and grey silicone rubber gasket as standard.
- ▶ Bronze anodised aluminium with black cover strip and black silicone rubber gasket or other powder-coated colour finishes are subject to non-standard charges and additional lead times.

### Certification

## PERIMETER SEALS

# LAS7003 si

MEDIUM DUTY **33dB**

Slimline, medium duty perimeter seal designed to be compressed between the door and the stop when the door is closed, compensating for warped or unevenly hung doors. Designed to be fitted to existing door stops. A neat cover plate conceals fixing screws. Easily installed without removing the door.

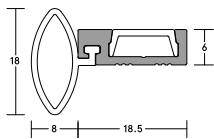

▲ LAS7003 si



▲ LAS7003 si

PERIMETER SEALS

### SYSTEM SPECIFICATIONS

#### Test evidence

- ▶ Acoustic: BS EN ISO 10140-2:2010 (up to  $R_w$  33dB).
- ▶ Smoke: BS 476-31.1: 1983.
- ▶ Durability: 100,000 cycles.

#### Performance

- ▶ Meets smoke requirement: BS 9999: 2017.
- ▶ Protects against sound, smoke, weather, draught and light.

#### Location

- ▶ Head and jambs of single swing doors.

#### Use with

- ▶ Practically any threshold seal.

#### Seal material

- ▶ Flexible silicone rubber.

#### Standard lengths

- ▶ 1m and 2.1m. Single doorset pack consisting of 1 x 1m and 2 x 2.1m. Other lengths to special order.

#### Fixing

- ▶ Self-tapping wood screws are supplied (self-drilling and self-tapping screws for metal construction available on request)
- ▶ Fixing holes are pre-drilled and slotted to allow the seals to be adjusted and positioned accurately. A PVC cover strip to conceal fixings is supplied.

#### Finishes

- ▶ Silver anodised aluminium with grey cover strip and grey silicone rubber gasket as standard.
- ▶ Bronze anodised aluminium with black cover strip and black silicone rubber gasket or other powder-coated colour finishes are subject to non-standard charges and additional lead times.

#### Certification

## PERIMETER SEALS

# LAS7004 si

MEDIUM DUTY **34dB**

Slimline, medium duty perimeter seal designed for timber doors with plain or rebated meeting stiles and where a centre latch is required. The leg of this seal can be cut out to accommodate the latch plate. Easily installed without removing the door.



PERIMETER SEALS

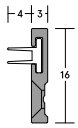

▲ LAS7004 si  
4mm

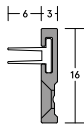

▲ LAS7004 si  
6mm



### SYSTEM SPECIFICATIONS

#### Test evidence

- ▶ Acoustic: BS EN ISO 10140-2:2010 (up to  $R_w$  34dB).
- ▶ Note: two rows of twin elastomeric fins will provide optimum acoustic performance.

#### Performance

- ▶ Protects against sound, smoke, weather, draught and light.

#### Location

- ▶ Meeting stiles of single and double swing doors.
- ▶ Sliding and revolving doors.

#### Use with

- ▶ Practically any threshold seal.

#### Seal material

- ▶ Choose from: (i) 4mm projection twin elastomeric fins (ii) 6mm projection twin elastomeric fins.

#### Standard lengths

- ▶ 1m and 2.1m. Other lengths to special order.

#### Fixing

- ▶ Wood screws are supplied (self-tapping screws for metal frames are available on request).
- ▶ Fixing holes are predrilled and countersunk.

#### Finishes

- ▶ Silver anodised aluminium with grey cover strip and grey silicone rubber gasket as standard.
- ▶ Bronze anodised aluminium with black cover strip and black silicone rubber gasket or other powder-coated colour finishes are subject to non-standard charges and additional lead times.

# LAS7005 si

MEDIUM DUTY **31dB**

A neat, aesthetically designed, compact perimeter seal with proven effective acoustic performance. Decorative cover strip conceals fixings. This seal can be used to replace the stop on steel or timber framed doors. To avoid excessive impact on the seal we recommend using a door closer to aid closing control.

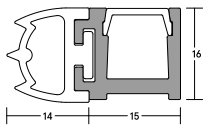

▲ LAS7005 si



PERIMETER SEALS

## SYSTEM SPECIFICATIONS

### Test evidence

- ▶ Acoustic: BS EN ISO 10140-2:2010 (up to Rw 31dB).

### Performance

- ▶ Protects against sound, smoke, weather, draught and light.

### Location

- ▶ Head and jambs of single swing doors.

### Use with

- ▶ Practically any threshold seal.

### Seal material

- ▶ Flexible silicone rubber.

### Standard lengths

- ▶ 1m and 2.1m. Single doorset pack consisting of 1 x 1m and 2 x 2.1m.
- ▶ Other lengths to special order.

### Fixing

- ▶ Self-tapping wood screws are supplied (self-drilling and self-tapping screws for metal construction available on request)
- ▶ Fixing holes are pre-drilled and slotted to allow the seals to be adjusted and positioned accurately. A PVC cover strip to conceal fixings is supplied.

### Finishes

- ▶ Silver anodised aluminium with grey cover strip and grey silicone rubber gasket as standard.
- ▶ Bronze anodised aluminium with black cover strip and black silicone rubber gasket or other powder-coated colour finishes are subject to non-standard charges and additional lead times.

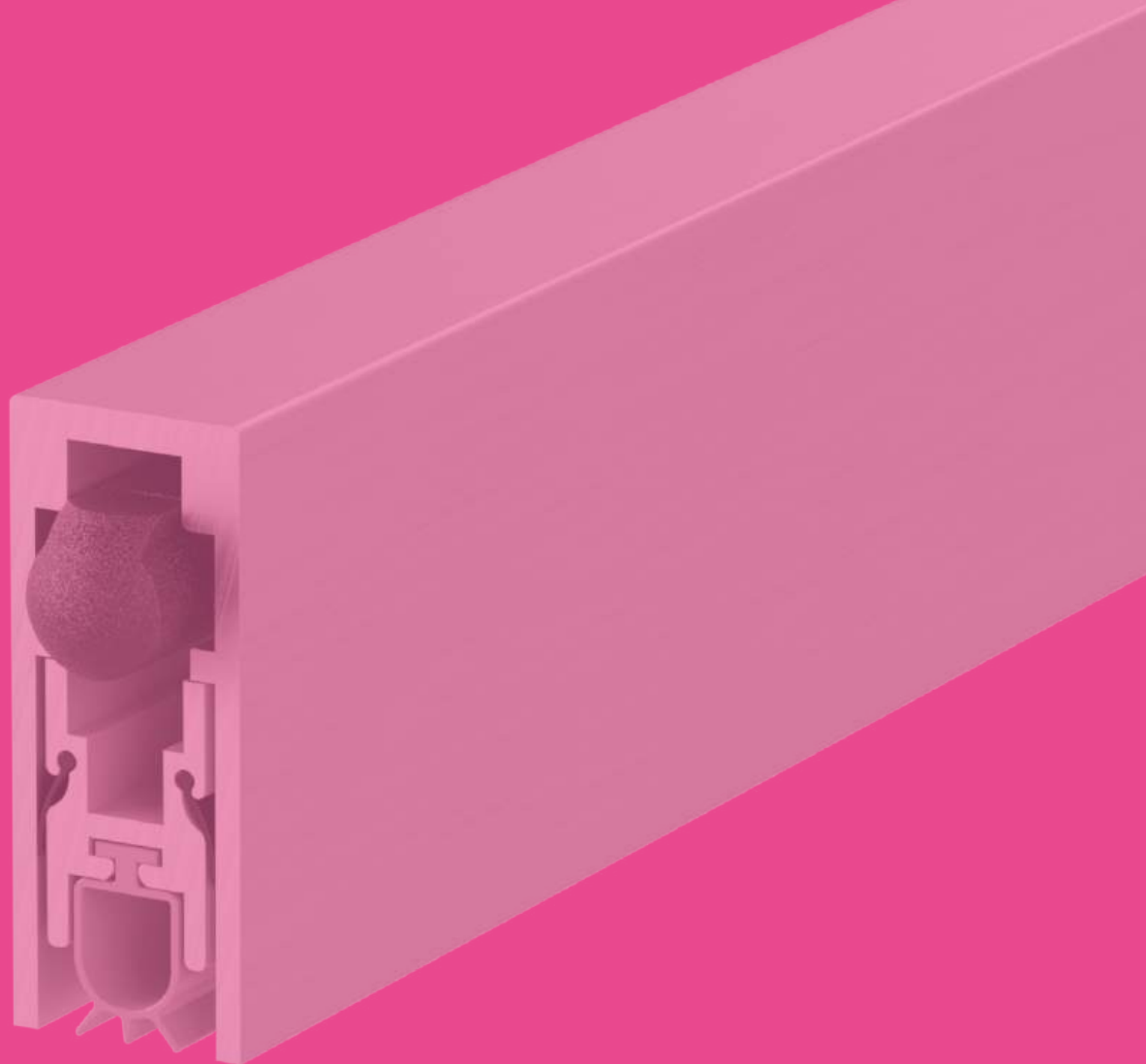

# ▼ DROP SEALS

A range of drop seals that fit to the bottom of a door and drop down automatically when the door closes to form a firm seal. Options include face-fixed installation, and semi or fully mortising into door leaves, for both medium and heavy duty applications.

A spring-loaded mechanism, requiring no power, ensures easy door operation and effective sealing when closed.



## DROP SEALS

# AAS8501 si

HEAVY DUTY **39dB**

A highly effective, self levelling drop seal with a unique wrap-around gasket for optimum acoustic and smoke containment. Coloured bands on the brass button help with fine adjustment for varying door gaps.

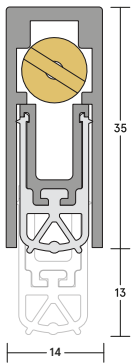

AAS8501 si



AAS8501 drop seal

DROP SEALS

## SYSTEM SPECIFICATIONS

### Test evidence

- ▶ Smoke: BS EN 1634-3: 2004 & BS 476-31.1: 1983 at ambient temperature.
- ▶ Acoustic: BS EN ISO 10140-2: 2010, BS EN ISO 10140-1: 2010 + A2: 2014 (Annex J) up to Rw 41dB.
- ▶ Durability: 100,000 cycles.

### Performance

- ▶ Meets smoke requirement: BS 9999:2017.
- ▶ Protects against sound, smoke, draught, light and dust.
- ▶ Suitable for wheeled traffic.

### Location

- ▶ Single swing doors. For use on both right and left handed doors.

### Use with

- ▶ Any perimeter seal. Any threshold plate.

### Min/max gap size

- ▶ 1mm/13mm.

### Seal material

- ▶ Grey or black silicone rubber.

### Standard lengths

- ▶ 335mm, 435mm, 535mm, 635mm, 735mm, 835mm, 935mm, 1035mm, 1135mm and 1235mm. Sizes above 1235mm are available on request.
- ▶ Note: Each length can be cut back to the next size down. The 335mm can be cut back to 255mm.

### Fixing

- ▶ Secured via stainless steel radiused end plates (21mm x 57mm). Two coloured bands on the adjuster indicate a nominal 10mm gap (blue) and the maximum 13mm gap (red), but any gap size from 1mm – 13mm can be accommodated

### Adjustment

- ▶ Self-levelling on uneven surfaces.

### Finishes

- ▶ Silver anodised aluminium with silver end plates, and grey silicone rubber gasket as standard.
- ▶ Silver anodised aluminium with bronze end plates, and black silicone rubber gasket are subject to non-standard charges and additional lead times.

### Certification

## DROP SEALS

# LAS8001 si

HEAVY DUTY **39dB**

A slimline, mortised automatic drop seal. It features a high efficiency mechanism, which lifts the seal clear of the floor as soon as the door is opened by a few millimetres; resulting in lower door operating forces. Requires no power connection. Self-levelling on uneven floors; seal height can be adjusted independently of fixing screws.



DROP SEALS

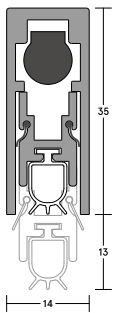

LAS8001 si



LAS8001 si (shown with LAS4001)

## SYSTEM SPECIFICATIONS

### Test evidence

- ▶ Fire: BS EN 1634-1:2014 + A1:2018 & BS 476-22:1987.
- ▶ Smoke: BS 476-31.1: 1983 at ambient temperature; BS EN 1634-3:2004 at ambient and medium temperature; effective smoke seal up to 200°C.
- ▶ Acoustic: BS EN ISO 10140-2:2010 (up to Rw 39dB).
- ▶ Durability: 100,000 cycles.

### Performance

- ▶ Meets smoke requirement: BS 9999:2017.
- ▶ Protects against sound, smoke, fire, draught, light and insects.
- ▶ Suitable for wheeled traffic.

### Location

- ▶ Single swing, single and double leaf doors. For use on both right and left handed doors.

### Use with

- ▶ Any perimeter seal. Any threshold plate.

### Min/max gap size

- ▶ 1mm/13mm.

### Seal material

- ▶ Grey or black silicone rubber.

### Standard lengths

- ▶ 335mm, 435mm, 535mm, 635mm, 735mm, 835mm, 935mm, 1035mm, 1135mm and 1235mm. Sizes above 1235mm are available on request.
- ▶ Note: Each length can be cut back to the next size down. The 335mm can be cut back to 255mm.

### Fixing

- ▶ Fixing screws are supplied. This seal is mortised. Pre-drilled radiused end plates are supplied which also secure the product in place. (Square end plates available on request).

### Adjustment

- ▶ Self-levelling on uneven surfaces.

### Finishes

- ▶ Silver anodised aluminium with silver end plates, and grey silicone rubber gasket as standard.
- ▶ Silver anodised aluminium with bronze end plates, and black silicone rubber gasket are subject to non-standard charges and additional lead times.

### Certification

## DROP SEALS

# LAS8001M

## HEAVY DUTY

A slimline, mortised automatic drop seal for timber sliding doors. The end plate cleverly conceals a magnet which engages with a button in the frame, to assist the door closure and ensures the gasket remains in the dropped position without forcing the door open. The seal features a high efficiency mechanism, which lifts the seal clear of the floor as soon as the door is opened by a few millimetres; resulting in lower door operating forces.

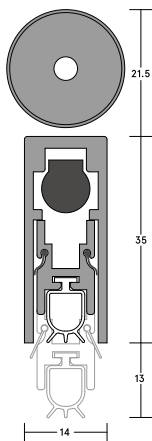

LAS8001M



DROP SEALS

### SYSTEM SPECIFICATIONS

#### Performance

- ▶ Protects against sound, smoke, draught, light and insects.
- ▶ Suitable for wheeled traffic.

#### Location

- ▶ Sliding doors.

#### Use with

- ▶ Any perimeter seal. Any threshold plate.

#### Min/max gap size

- ▶ 1mm/13mm.

#### Seal material

- ▶ Grey or black silicone rubber.

#### Standard lengths

- ▶ 335mm, 435mm, 535mm, 635mm, 735mm, 835mm, 935mm, 1035mm, 1135mm and 1235mm. Sizes above 1235mm are available on request.

- ▶ Note: Each length can be cut back to the next size down. The 335mm can be cut back to 255mm.

#### Fixing

- ▶ Fixing screws are supplied. This seal is mortised. Pre-drilled radiused end plates are supplied which also secure the product in place. (Square end plates available on request).
- ▶ Magnetised button is supplied to fix into the frame.

#### Adjustment

- ▶ Self-levelling on uneven surfaces. Can be adjusted independently of the fixing screws.

#### Finishes

- ▶ Silver anodised aluminium with silver end plates, and grey silicone rubber gasket as standard.
- ▶ Silver anodised aluminium with bronze end plates, and black silicone rubber gasket are subject to non-standard charges and additional lead times.
- ▶ Chrome finish magnetised button.

## DROP SEALS

# LAS8002 si

MEDIUM DUTY **31dB**

A slimline face-fixed automatic drop seal. It features a high efficiency mechanism, which lifts the seal clear of the floor as soon as the door is opened by a few millimetres; resulting in lower door operating forces. Surface mounted application suitable for upgrading existing doors. Requires no power connection. Self-levelling on uneven floors; seal height can be adjusted independently of fixing screws.



DROP SEALS

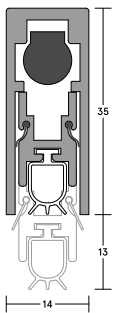

LAS8002 si



LAS8002 si (shown with LAS4001)

## SYSTEM SPECIFICATIONS

### Test evidence

- ▶ Smoke: BS 476-31.1: 1983 & BS EN 1634-3:2004 at ambient temperature.
- ▶ Acoustic: BS EN ISO 10140-2:2010 (up to Rw 31dB).

### Performance

- ▶ Meets smoke requirement: BS 9999:2017.
- ▶ Suitable for use on timber fire doors.
- ▶ Protects against sound, smoke, fire, draught, light and insects. Suitable for wheeled traffic.

### Location

- ▶ Single swing, single and double leaf doors.
- ▶ For use on both right and left handed doors.

### Use with

- ▶ Any perimeter seal. Any threshold plate.

### Min/max gap size

- ▶ 1mm/13mm.

### Seal material

- ▶ Grey silicone rubber.

### Standard lengths

- ▶ 335mm, 435mm, 535mm, 635mm, 735mm, 835mm, 935mm, 1035mm, 1135mm and 1235mm.
- ▶ Note: Each length can be cut back to the next size down. The 335mm can be cut back to 255mm.

### Fixing

- ▶ LAS8002 si is face-fixed onto the door bottom.
- ▶ Screw fix using screws provided. Fit end caps.

### Adjustment

- ▶ Self-levelling on uneven surfaces.
- ▶ Can be adjusted independently of the fixing screws.

### Finishes

- ▶ Silver anodised aluminium with grey end caps and grey silicone rubber gasket as standard.
- ▶ Other powder-coated colour finishes (non-standard - charges and lead times apply).
- ▶ Black end caps, and black silicone rubber gasket (non-standard - charges and lead times apply).

### Certification

## DROP SEALS

# LAS8002G si

## MEDIUM DUTY

A slimline face-fixed drop seal suitable for glass doors – hinged into timber or aluminium frames. A smooth back plate creates a visual aesthetic. LAS8002G si features a high efficiency mechanism, which lifts the seal clear of the floor as soon as the door is opened by a few millimetres; resulting in lower door operating forces.

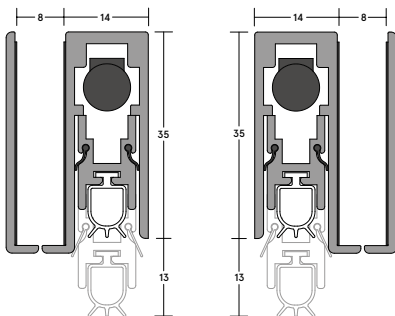

▲ LAS8002G si  
(right handed)

▲ LAS8002G si  
(left handed)



DROP SEALS

▲ LAS8002G si (shown with LAS4001)

### SYSTEM SPECIFICATIONS

#### Test evidence

- ▶ Durability: 100,000 cycles.

#### Performance

- ▶ Meets smoke requirement: BS 9999:2017.
- ▶ Protects against smoke, draught and insects.
- ▶ Suitable for wheeled traffic.

#### Location

- ▶ Single swing doors.
- ▶ For use on both right and left handed doors.

#### Use with

- ▶ Any perimeter seal. Any threshold plate.

#### Min/max gap size

- ▶ 1mm/10mm.

#### Seal material

- ▶ Grey silicone rubber.

#### Standard lengths

- ▶ 335mm, 435mm, 535mm, 635mm, 735mm, 835mm, 935mm, 1035mm, 1135mm and 1235mm.
- ▶ Note: Each length can be cut back to the next size down. The 335mm can be cut back to 255mm.

#### Fixing

- ▶ LAS8002G si carrier and back plate are face-fixed with strong adhesive tape.
- ▶ Fit end caps.
- ▶ This product is non-reversible and needs to be ordered left or right handed.

#### Adjustment

- ▶ Self-levelling on uneven surfaces.

#### Finishes

- ▶ Silver anodised aluminium with grey end caps and grey silicone rubber gasket as standard.
- ▶ Bronze anodised aluminium with black end caps and black silicone rubber gasket are subject to non-standard charges and additional lead times.
- ▶ Other powder-coated colour finishes (non-standard – charges and lead times apply).

## DROP SEALS

# LAS8003 si

MEDIUM DUTY **33dB**

A slimline face-fixed automatic drop seal. It features a high efficiency mechanism, which lifts the seal clear of the floor as soon as the door is opened by a few millimetres; resulting in lower door operating forces. Surface mounted application suitable for upgrading existing doors. Requires no power connection. Self-levelling on uneven floors; seal height can be adjusted independently of fixing screws.



DROP SEALS

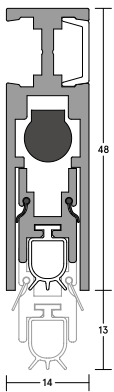

LAS8003 si

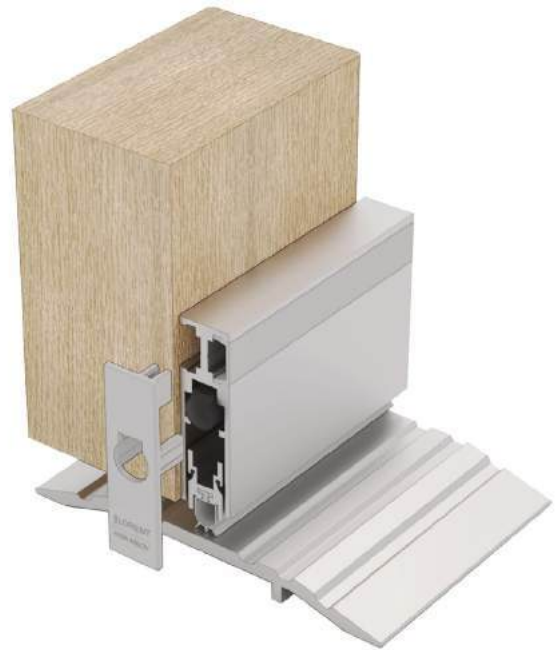

LAS8003 si (shown with LAS4100)

## SYSTEM SPECIFICATIONS

### Test evidence

- ▶ Smoke: BS 476-31.1: 1983 at ambient temperature.
- ▶ Acoustic: BS EN ISO 10140-2: 2010 (up to Rw 33dB).

### Performance

- ▶ Meets smoke requirement: BS 9999:2017.
- ▶ Suitable for use on timber fire doors.
- ▶ Protects against sound, smoke, draught, light and insects. Suitable for wheeled traffic.

### Location

- ▶ Single swing, single and double leaf doors.
- ▶ For use on both right and left handed doors.

### Use with

- ▶ Any perimeter seal. Any threshold plate.

### Min/max gap size

1mm/13mm.

### Seal material

- ▶ Grey silicone rubber.

### Standard lengths

- ▶ 335mm, 435mm, 535mm, 635mm, 735mm, 835mm, 935mm, 1035mm, 1135mm and 1235mm.
- ▶ Note: Each length can be cut back to the next size down. The 335mm can be cut back to 255mm.

### Fixing

- ▶ LAS8003 si is face-fixed onto the door bottom. Fixing screws are provided.

### Adjustment

- ▶ Self-levelling on uneven surfaces.
- ▶ Can be adjusted independently of the fixing screws.

### Finishes

- ▶ Silver anodised aluminium with grey end caps and grey silicone rubber gasket as standard.
- ▶ Other powder-coated colour finishes (non-standard - charges and lead times apply).
- ▶ Black end caps, and black silicone rubber gasket (non-standard - charges and lead times apply).

### Certification

## DROP SEALS

# LAS8004 si

## HEAVY DUTY

A heavy duty, mortised, automatic 'flat back' drop seal to suit installation to metal door rails. It features a high efficiency mechanism, which lifts the seal clear of the floor as soon as the door is opened by a few millimetres; resulting in lower door operating forces. Requires no power connection. Self-levelling on uneven floors; seal height can be adjusted independently of fixing screws.



DROP SEALS

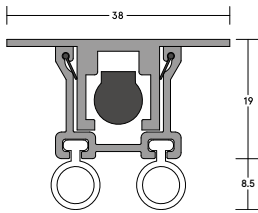

LAS8004 si

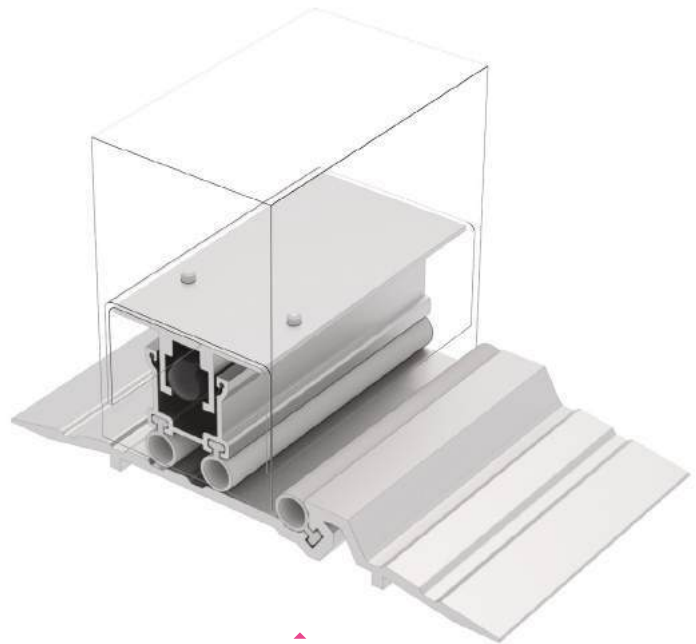

LAS8004 si  
(shown with LAS4014 si)

### SYSTEM SPECIFICATIONS

#### Test evidence

- ▶ Smoke: BS 476-31.1: 1983 at ambient temperature.
- ▶ Durability: 100,000 cycles.

#### Performance

- ▶ Meets smoke requirement: BS 9999:2017.
- ▶ Protects against smoke, draught, light and insects.
- ▶ Suitable for use of fire rated steel doorsets.
- ▶ Suitable for wheeled traffic.

#### Location

- ▶ Single swing, single and double leaf doors.
- ▶ Can be used on either right or left handed doors.

#### Use with

- ▶ Any threshold plate.

#### Min/max gap size

- ▶ 1mm/13mm.

#### Seal material

- ▶ Grey silicone gasket.

#### Standard lengths

- ▶ 635mm, 735mm, 835mm, 935mm, 1035mm, 1135mm and 1235mm.
- ▶ Note: Each length can be cut back to the next size down. The 635mm can be cut back to 535mm. Other lengths to special order.

#### Fixing

- ▶ Fixing screws are supplied, fixing holes are pre-drilled.

#### Adjustment

- ▶ Self-levelling on uneven surfaces.

#### Finish

- ▶ Silver anodised aluminium with grey gaskets.

#### Certification



## DROP SEALS

# LAS8005 si

HEAVY DUTY **33dB**

A slimline, mortised automatic drop seal. It features a high efficiency mechanism, which lifts the seal clear of the floor as soon as the door is opened by a few millimetres; resulting in lower door operating forces. Requires no power connection. Self-levelling on uneven floors; seal height can be adjusted independently of fixing screws. Can be fitted to aluminium doors by door fabricators.

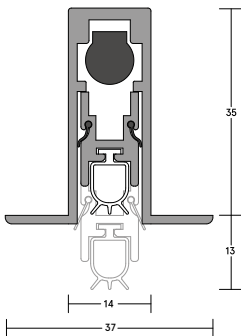

▲ LAS8005 si

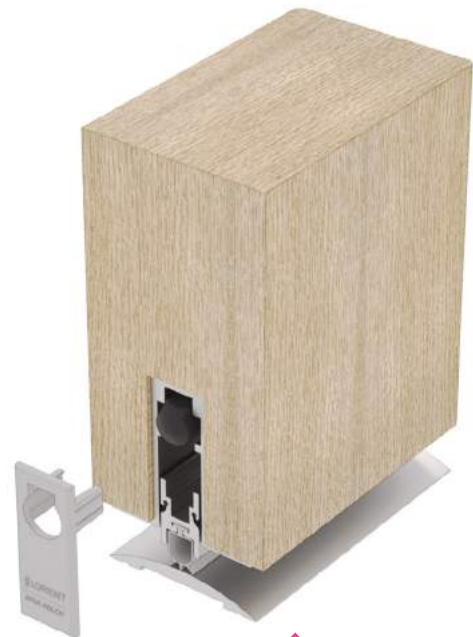

▲ LAS8005 si  
(shown with LAS4002)

DROP SEALS

## SYSTEM SPECIFICATIONS

### Test evidence

- ▶ Fire: BS 476-20/22:1987 & BS EN 1634-1:2014.
- ▶ Smoke: BS 476-31.1: 1983 & BS EN 1634-3:2004 at ambient temperature.
- ▶ Acoustic: BS EN ISO 10140-2:2010 (up to Rw 33dB).
- ▶ Durability: 100,000 cycles.

### Performance

- ▶ Meets smoke requirement: BS 9999:2017.
- ▶ Protects against sound, smoke, fire, draught, light and insects.
- ▶ Suitable for wheeled traffic.

### Location

- ▶ Single swing, single and double leaf doors.
- ▶ For use on both right and left handed doors.

### Use with

- ▶ Any perimeter seal. Any threshold plate.

### Min/max gap size

- ▶ 1mm/13mm.

### Seal material

- ▶ Grey silicone rubber.

### Lengths

- ▶ 335mm, 435mm, 535mm, 635mm, 735mm, 835mm, 935mm, 1035mm, 1135mm and 1235mm.
- ▶ Note: Each length can be cut back to the next size down. 335mm can be cut back to 255mm.

### Fixing

- ▶ This seal is mortised, and screw fixed via the flanges.
- ▶ Fixing screws are supplied; fixing holes are pre-drilled and countersunk.

### Adjustment

- ▶ Self-levelling on uneven surfaces. Seal height can be adjusted independently of the fixing screws.

### Finishes

- ▶ Silver anodised aluminium with grey end caps and grey silicone rubber gasket as standard.
- ▶ Other powder-coated colour finishes (non-standard - charges and lead times apply).
- ▶ Black end caps, and black silicone rubber gasket (non-standard - charges and lead times apply).

### Certification



## DROP SEALS

# LAS8006 si

HEAVY DUTY **30dB**

A heavy duty, face-fixed automatic drop seal. It features a high efficiency mechanism, which lifts the seal clear of the floor as soon as the door is opened by a few millimetres; resulting in lower door operating forces. Requires no power connection. Self-levelling on uneven floors; seal height can be adjusted independently of fixing screws.

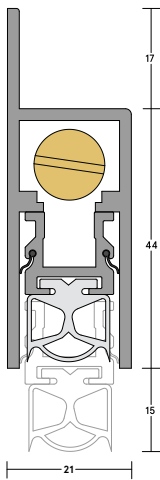

LAS8006 si



LAS8006 si (shown with LAS4010)

DROP SEALS

### SYSTEM SPECIFICATIONS

#### Test evidence

- ▶ Smoke: BS 476-31.1: 1983 at ambient temperature.
- ▶ Acoustic: BS EN ISO 10140-2:2010 (up to Rw 30dB).
- ▶ Durability: 100,000 cycles.

#### Performance

- ▶ Meets smoke requirement: BS 9999:2017.
- ▶ Suitable for use on timber fire doors.
- ▶ Protects against sound, smoke, fire, draught, light and insects.
- ▶ Suitable for wheeled traffic.

#### Location

- ▶ Single swing, single and double leaf doors.
- ▶ For use on both right and left handed doors.

#### Use with

- ▶ Any perimeter seal. Any threshold plate.

#### Min/max gap size

- ▶ 1mm/15mm.

#### Seal material

- ▶ Black or grey silicone rubber.

#### Standard lengths

- ▶ 335mm, 435mm, 535mm, 635mm, 735mm, 835mm, 935mm, 1035mm, 1135mm and 1235mm.
- ▶ Note: Each length can be cut back to the next size down. The 335mm can be cut back to 275mm.

#### Fixing

- ▶ Fixing screws are supplied, holes should be drilled at time of fixing.

#### Adjustment

- ▶ Self-levelling on uneven surfaces – can be adjusted independently of the fixing screws.

#### Finishes

- ▶ Silver anodised aluminium with grey end caps and grey silicone rubber gasket as standard.
- ▶ Other powder-coated colour finishes (non-standard – charges and lead times apply).
- ▶ Black end caps, and black silicone rubber gasket (non-standard – charges and lead times apply).

#### Certification

## DROP SEALS

# LAS8007 si

HEAVY DUTY **39dB**

A heavy duty mortised automatic drop seal. It features a high efficiency mechanism, which lifts the seal clear of the floor as soon as the door is opened by a few millimetres; resulting in lower door operating forces. Requires no power connection. Self-levelling on uneven floors; seal height can be adjusted independently of fixing screws. This is a fully-mortised version of LAS8006 si.



DROP SEALS

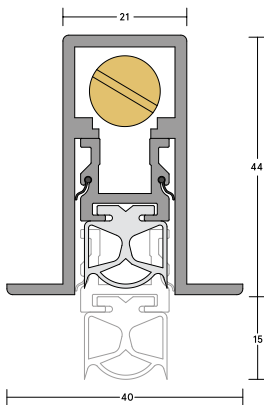

LAS8007 si



LAS8007 si (shown with LAS4011)

## SYSTEM SPECIFICATIONS

### Test evidence

- ▶ Smoke: BS 476-31.1: 1983 at ambient temperature.
- ▶ Acoustic: BS EN ISO 10140-1:2010+A2: 2014 (Annex J) up to Rw 39dB.
- ▶ Durability: 100,000 cycles.

### Performance

- ▶ Meets smoke requirement: BS 9999:2017.
- ▶ Protects against sound, smoke, draught, light and insects.
- ▶ Suitable for wheeled traffic.

### Location

- ▶ Single swing, single and double leaf doors.
- ▶ For use on both right and left handed doors.

### Use with

- ▶ Any perimeter seal. Any threshold plate.

### Min/max gap size

- ▶ 1mm/15mm.

### Seal material

- ▶ Black or grey silicone rubber.

### Standard lengths

- ▶ 335mm, 435mm, 535mm, 635mm, 735mm, 835mm, 935mm, 1035mm, 1135mm and 1235mm.
- ▶ Note: Each length can be cut back to the next size down. The 335mm can be cut back to 275mm.

### Fixing

- ▶ Fixing screws and end caps are supplied.
- ▶ Fixing holes are pre-drilled through the flanges.

### Adjustment

- ▶ Self-levelling on uneven surfaces - can be adjusted independently of the fixing screws.

### Finishes

- ▶ Silver anodised aluminium with grey end caps and grey silicone rubber gasket as standard.
- ▶ Other powder-coated colour finishes (non-standard - charges and lead times apply).
- ▶ Black end caps, and black silicone rubber gasket (non-standard - charges and lead times apply).

### Certification

## DROP SEALS

# LAS8008 si

MEDIUM DUTY **30dB**

A slimline face-fixed automatic drop seal with a curved cover plate for enhanced aesthetics. It features a high efficiency mechanism, which lifts the seal clear of the floor as soon as the door is opened by a few millimetres; resulting in lower door operating forces. Requires no power connection. Self-levelling on uneven floors, seal height can be adjusted independently of fixing screws. Suitable for upgrading existing doors.

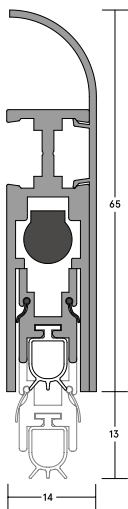

LAS8008 si



LAS8008 si (shown with LAS4011)

DROP SEALS

## SYSTEM SPECIFICATIONS

### Test evidence

- ▶ Smoke: BS 476-31.1: 1983 & BS EN 1634-3:2004 at ambient temperature.
- ▶ Acoustic: BS EN ISO 10140-2: 2010 (up to Rw 30dB).

### Performance

- ▶ Meets smoke requirement: BS 9999:2017.
- ▶ Suitable for use on timber fire doors. Protects against sound, smoke, fire, draught, light and insects.
- ▶ Suitable for wheeled traffic.

### Location

- ▶ Single swing, single and double leaf doors.
- ▶ For use on both right and left handed doors.

### Use with

- ▶ Any perimeter seal. Any threshold plate.

### Min/max gap size

1mm/13mm.

### Seal material

- ▶ Grey silicone rubber.

### Standard lengths

- ▶ 335mm, 435mm, 535mm, 635mm, 735mm, 835mm, 935mm, 1035mm, 1135mm and 1235mm.
- ▶ Note: Each length can be cut back to the next size down. The 335mm can be cut back to 255mm.

### Fixing

- ▶ Fixing screws are supplied, holes should be drilled at time of fixing. LAS8008 si is face-fixed only.

### Adjustment

- ▶ Self-levelling on uneven surfaces.
- ▶ Can be adjusted independently of the fixing screws.

### Finishes

- ▶ Silver anodised aluminium with grey end caps and grey silicone rubber gasket as standard.
- ▶ Other powder-coated colour finishes (non-standard - charges and lead times apply).
- ▶ Black end caps, and black silicone rubber gasket (non-standard - charges and lead times apply).

## DROP SEALS

# LAS8009 si

HEAVY DUTY **31dB**

A heavy duty face-fixed automatic drop seal with curved cover plate that conceals fixing screws and presents an exceptionally smooth external aspect. It features a high efficiency mechanism, which lifts the seal clear of the floor as soon as the door is opened by a few millimetres; resulting in lower door operating forces. Requires no power connection. Self-levelling on uneven floors; seal height can be adjusted independently of fixing screws.



DROP SEALS

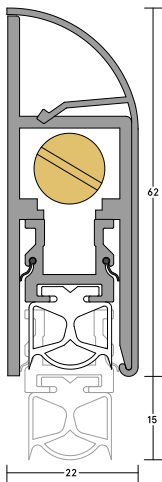

LAS8009 si



LAS8009 si (shown with LAS4055)

### SYSTEM SPECIFICATIONS

#### Test evidence

- ▶ Smoke: BS 476-31.1: 1983 at ambient temperature.
- ▶ Acoustic: BS EN ISO 10140-2: 2010 (up to Rw 31dB).

#### Performance

- ▶ Meets smoke requirement: BS 9999:2017.
- ▶ Suitable for use on timber fire doors.
- ▶ Protects against sound, smoke, fire, draught, light and insects.
- ▶ Suitable for wheeled traffic.

#### Location

- ▶ Single swing, single and double leaf doors.
- ▶ For use on both right and left handed doors.

#### Use with

- ▶ Any perimeter seal. Any threshold plate.

#### Min/max gap size

- ▶ 1mm/15mm.

#### Seal material

- ▶ Black or grey silicone rubber.

#### Standard lengths

- ▶ 335mm, 435mm, 535mm, 635mm, 735mm, 835mm, 935mm, 1035mm, 1135mm and 1235mm.
- ▶ Note: Each length can be cut back to the next size down. The 335mm can be cut back to 275mm.

#### Fixing

- ▶ Fixing screws are supplied, holes should be drilled at time of fixing. End caps are supplied.

#### Adjustment

- ▶ Self-levelling on uneven surfaces – can be adjusted independently of the fixing screws.

#### Finishes

- ▶ Silver anodised aluminium with grey end caps and grey silicone rubber gasket as standard.
- ▶ Other powder-coated colour finishes (non-standard – charges and lead times apply).
- ▶ Black end caps, and black silicone rubber gasket (non-standard – charges and lead times apply).

#### Certification

## DROP SEALS

# LAS8012 si

HEAVY DUTY **43dB**

A heavy duty automatic drop seal designed for optimum acoustic performance. Requires no power connection. Self-levelling on uneven floors; seal height can be adjusted independently of fixing screws. Supplied with standard nylon end caps. Die cast end plates in a metallic finish for premium aesthetics are an option.

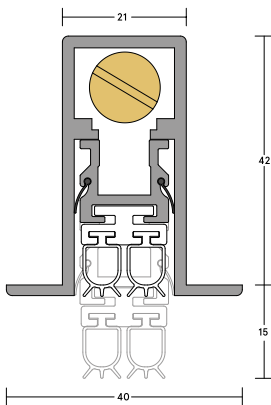

LAS8012 si



LAS8012 si (shown with LAS4002)

DROP SEALS

## SYSTEM SPECIFICATIONS

### Test evidence

- ▶ Acoustic: BS EN ISO 10140-1:2010+A2:2014 (Annex J) up to Rw 43dB.

### Performance

- ▶ Meets smoke requirement: BS 9999:2017.
- ▶ Protects against sound, smoke, draught, light and insects.
- ▶ Suitable for wheeled traffic.

### Location

- ▶ Single swing, single and double leaf doors.
- ▶ For use on both right and left handed doors.

### Use with

- ▶ Any perimeter seal. Any threshold plate.

### Min/max gap size

- ▶ 1mm/15mm.

### Seal material

- ▶ Black or grey silicone rubber.

### Standard lengths

- ▶ 335mm, 435mm, 535mm, 635mm, 735mm, 835mm, 935mm, 1035mm, 1135mm and 1235mm.
- ▶ Note: Each length can be cut back to the next size down. The 335mm can be cut back to 275mm.

### Fixing

- ▶ Fixing screws are supplied, fixing holes are pre-drilled through the flanges.
- ▶ Both square and radiused end plates are available - state your preference at point of order.

### Adjustment

- ▶ Self-levelling on uneven surfaces - can be adjusted independently of the fixing screws.

### Finishes

- ▶ Silver anodised aluminium with grey end caps and grey silicone rubber gasket as standard.
- ▶ Silver anodised aluminium with black end caps and black silicone rubber gasket (non-standard - charges and lead times apply).
- ▶ The non-button end cap is designed blank, creating an engineered smooth aesthetic.

## DROP SEALS

# LAS8013 si

HEAVY DUTY **43dB**

A heavy duty automatic drop seal designed for optimum performance. It requires no power connection. Self-levelling on uneven floors; seal height can be adjusted independently of fixing screws. Supplied with standard nylon end caps. Die cast end plates in a metallic finish for premium aesthetics are an option.



DROP SEALS

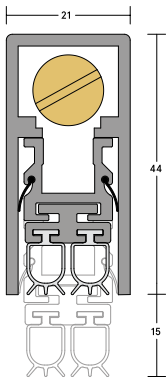

LAS8013 si



LAS8013 si (shown with LAS4002)

### SYSTEM SPECIFICATIONS

#### Test evidence

- ▶ Acoustic: BS EN ISO 10140-1:2010+A2:2014 (Annex J) up to Rw 43dB.

#### Performance

- ▶ Meets smoke requirement: BS 9999:2017.
- ▶ Protects against sound, smoke, draught, light and insects.
- ▶ Suitable for wheeled traffic.

#### Location

- ▶ Single swing, single and double leaf doors.
- ▶ For use on both right and left handed doors.

#### Use with

- ▶ Any perimeter seal. Any threshold plate.

#### Min/max gap size

- ▶ 1mm/15mm.

#### Seal material

- ▶ Black or grey silicone rubber.

#### Standard lengths

- ▶ 335mm, 435mm, 535mm, 635mm, 735mm, 835mm, 935mm, 1035mm, 1135mm and 1235mm.
- ▶ Note: Each length can be cut back to the next size down. The 335mm can be cut back to 275mm.

#### Fixing

- ▶ This seal is mortised. Pre-drilled end plates are supplied which also secure the product in place. Fixing screws are supplied.
- ▶ Both square and radiused end plates are available - state your preference at point of order.

#### Adjustment

- ▶ Self-levelling on uneven surfaces - can be adjusted independently of the fixing screws.

#### Finishes

- ▶ Silver anodised aluminium with grey end caps and grey silicone rubber gasket as standard.
- ▶ Silver anodised aluminium with black end caps and black silicone rubber gasket (non-standard - charges and lead times apply).
- ▶ The non-button end cap is designed blank, creating an engineered smooth aesthetic.

## DROP SEALS

# LAS8014 si

HEAVY DUTY 47dB

A durable, heavy duty automatic drop seal featuring a wrap-around outer gasket with an additional internal gasket designed for superior acoustic performance. The seal features a parallel drop mechanism. It is spring-loaded to lift clear of the floor as soon as the door is opened by a few millimetres. Die cast end plates are available in a metallic finish for premium aesthetics.

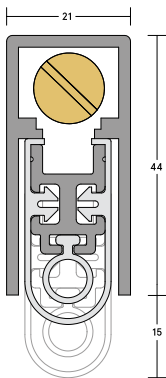

LAS8014 si



LAS8014 si (shown with LAS4002)

DROP SEALS

### SYSTEM SPECIFICATIONS

#### Test evidence

- ▶ Smoke: BS EN 1634-3:2004 at ambient temperature.
- ▶ Acoustic: BS EN ISO 10140-1: 2010+A2: 2014 (Annex J) up to Rw 47dB.
- ▶ Durability: 1 million cycles.

#### Performance

- ▶ Meets smoke requirement: BS 9999:2017.
- ▶ Protects against sound, smoke, draught, light and insects.
- ▶ Suitable for wheeled traffic.
- ▶ Parallel drop mechanism.

#### Location

- ▶ Single swing, single and double leaf doors.
- ▶ For use on both right and left handed doors.

#### Use with

- ▶ Any perimeter seal. Any threshold plate.

#### Min/max gap size

- ▶ 6mm/15mm.

#### Seal material

- ▶ Grey silicone rubber.

#### Standard lengths

- ▶ 335mm, 435mm, 535mm, 635mm, 735mm, 835mm, 935mm, 1035mm, 1135mm and 1235mm.
- ▶ Note: Other lengths can be cut back to the next size down. The 535mm can be cut back to 495mm. The 335mm can be cut back to 255mm.

#### Fixing

- ▶ Pre-drilled end plates are supplied which also secure the product in place. Fixing screws are supplied.
- ▶ Both square and radiused end plates are available - state your preference at point of order.

#### Adjustment

- ▶ Self-levelling on uneven surfaces - can be adjusted independently of the fixing screws.

#### Finishes

- ▶ Silver anodised aluminium, grey silicone rubber gasket as standard.
- ▶ The non-button end cap is designed blank, creating an engineered smooth aesthetic.



DROP SEALS

# LAS8040

MEDIUM DUTY **40dB**

A medium duty, mortised automatic drop seal. The unique double activated mechanism has an adjustable brass striker button at the hinge side and a nylon striker at the latch side. The mechanism also contains additional internal seals and a double compression facility to provide exceptional acoustic performance. Can be used for both 44mm and 54mm doors.



DROP SEALS

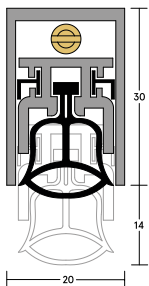

LAS8040



LAS8040 (shown with LAS4001)

SYSTEM SPECIFICATIONS

**Test evidence**

- ▶ Acoustic: BS EN ISO 10140-2:2010 (up to Rw 40dB).

**Performance**

- ▶ Meets smoke requirement: BS 9999:2017.
- ▶ Protects against sound, smoke, draught, light and insects.
- ▶ Suitable for wheeled traffic.

**Location**

- ▶ Single swing, single leaf doors. For use on both right and left handed doors.

**Use with**

- ▶ Any perimeter seal.
- ▶ Any threshold plate.

**Min/max gap size**

- ▶ 3mm/14mm.

**Seal material**

- ▶ Flexible thermoplastic elastomer gasket and internal fins.

**Fixing**

- ▶ Appropriate fixing screws are supplied, fixing holes are pre-drilled.
- ▶ Striker plates, which are located in the door jambs are supplied. This seal must be mortised.

**Adjustment**

- ▶ Self-levelling on uneven surfaces – can be adjusted independently of fixing screws. Adjust using the buttons at either end of the seal.

**Finish**

- ▶ Silver anodised aluminium with black flexible gasket.

Seal	Length	Cut back	Cut location
LAS8040	535mm	80mm	Brass button end
LAS8040	635mm	100mm	50mm from each end
LAS8040	735mm	100mm	50mm from each end
LAS8040	835mm	100mm	50mm from each end
LAS8040	935mm	100mm	50mm from each end
LAS8040	1035mm	100mm	50mm from each end
LAS8040	1135mm	100mm	50mm from each end



## DROP SEALS

# LAS8060

## MEDIUM DUTY

A grade 304 stainless steel, medium duty automatic drop seal. It features a high efficiency mechanism, which lifts the seal clear of the floor as soon as the door is opened by a few millimetres; resulting in lower door operating forces. Requires no power connection.

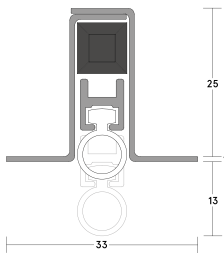

▲  
LAS8060



▲  
LAS8060  
(shown with LAS4050)

DROP SEALS

### SYSTEM SPECIFICATIONS

#### Performance

- ▶ Meets smoke requirement: BS 9999:2017.
- ▶ Protects against sound, smoke, draught, light and insects.
- ▶ Suitable for wheeled traffic.

#### Location

- ▶ Single swing, single and double leaf doors.
- ▶ For use on both right and left handed doors.

#### Use with

- ▶ Any perimeter seal. Any threshold plate.

#### Min/max gap size

- ▶ 3mm/13mm.

#### Seal material

- ▶ Thermoplastic elastomer.

#### Lengths

- ▶ 725mm, 825mm, 925mm and 1025mm.
- ▶ Note: Each length can be reduced for an exact fit by up to 110mm.

#### Fixing

- ▶ Fixing screws are supplied, fixing holes are pre-drilled. Striker button, which locates in the door jamb, is supplied.
- ▶ End plates not supplied.

#### Adjustment

- ▶ Self-levelling on uneven surfaces. Adjustment can be carried out independently of the fixing screws.

#### Finish

- ▶ Stainless steel with grey thermoplastic elastomer gasket.

#### Specification

## DROP SEALS

# LAS8070

## HEAVY DUTY

A grade 304 stainless steel heavy duty automatic drop seal. It features a high efficiency mechanism, which lifts the seal clear of the floor as soon as the door is opened by a few millimetres; resulting in lower door operating forces. Requires no power connection. Impervious to most chemicals, solvents, cleaning fluids and disinfectants.



DROP SEALS

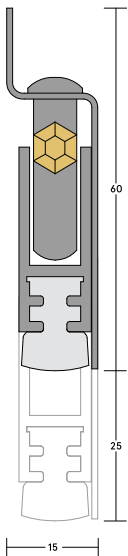

LAS8070

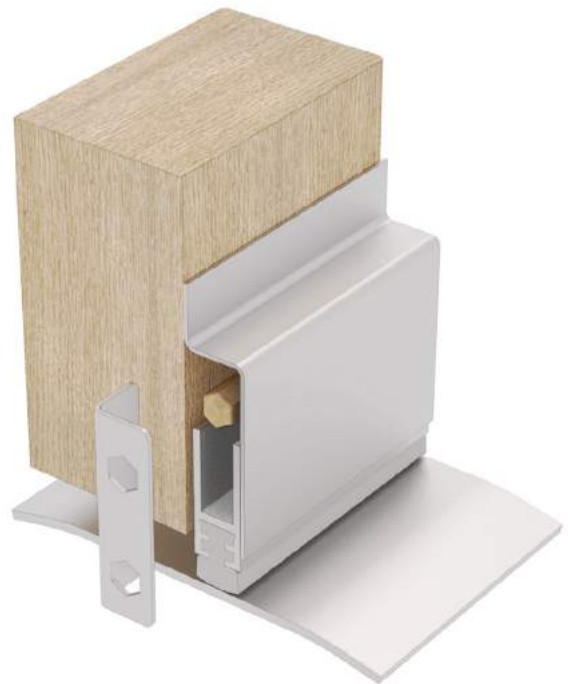

LAS8070 (shown with LAS4055)

### SYSTEM SPECIFICATIONS

#### Performance

- ▶ Suitable for use on timber fire doors.
- ▶ Protects against sound, smoke, fire, draught, light and insects.
- ▶ Suitable for wheeled traffic.

#### Location

- ▶ Single swing, single and double leaf doors.
- ▶ For use on both right and left handed doors.

#### Use with

- ▶ Any perimeter seal. Any threshold plate.

#### Min/max gap size

- ▶ 1mm/25mm.

#### Seal material

- ▶ Foamed silicone rubber.

#### Standard lengths

- ▶ 610mm, 710mm, 815mm, 915mm, 1015mm, 1120mm and 1220mm.
- ▶ Note: 610mm and 710mm length can be cut back by 80mm. All other lengths can be cut back by 100mm.

#### Fixing

- ▶ Fixing screws are supplied, fixing holes are pre-drilled. Striker button, which locates in the door stop, is supplied.
- ▶ End plates are supplied.

#### Adjustment

- ▶ Self-levelling on uneven surfaces. Adjustment can be carried out independently of fixing screws.

#### Finish

- ▶ Brushed stainless steel with grey silicone rubber insert.

#### Specification

# FINGER GUARDS & SPECIALITY SEALS

A range of speciality seals that features finger guards, drip guards and a flush bolt + drop seal.

Trapping fingers in hinged doors can cause horrendous injuries.

The risk is especially high where young children are present. Our finger guard seals provide a shield, helping prevent thousands of accidents.

## SPECIALITY SEALS

# LAS9001

## MEDIUM DUTY

An overhead drip guard designed to channel rain water away from exposed doors, particularly those which open outward. Can also be used to deflect rainwater from the bottom of the door.

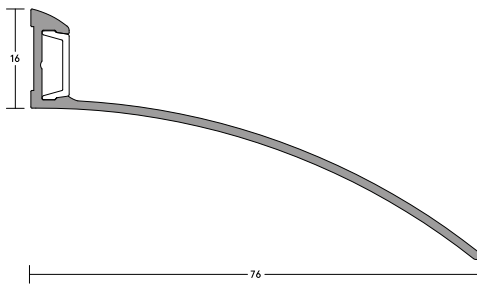

LAS9001



### SYSTEM SPECIFICATIONS

#### Performance

- ▶ Protects against weather/rain.

#### Location

- ▶ Single and double leaf doors.
- ▶ Sliding doors.
- ▶ Roller shutter doors.
- ▶ Up and over doors.

#### Seal material

- ▶ Extruded aluminium.

#### Standard lengths

- ▶ 1m and 2.1m.

#### Fixing

- ▶ Steel screws are supplied (self-drilling and self-tapping screws for metal construction available on request).
- ▶ A PVC cover strip conceals the fixings.
- ▶ Allow an overlap of 50mm on each side of door opening.

#### Finish

- ▶ Silver anodised aluminium.

# LAS9010 / LAS8001 si

MEDIUM DUTY **41dB**

An innovative, slimline flush bolt that seamlessly integrates with our most popular drop seal – LAS8001 si. The flush bolt is a security device to be used on pairs of doors to secure the inactive leaf. It is activated by a discreet Lorient branded lever, that drops the bolt into a sleek keep in the floor. Specifically designed for use with our rebated high performance drop seal; together they provide the ultimate system combining security, with acoustic, smoke and energy containment at the bottom of the door.

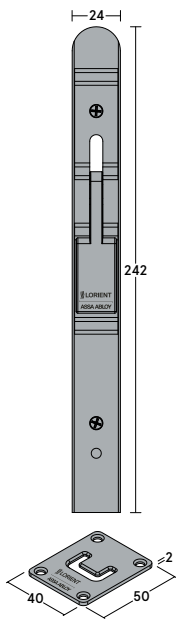

LAS9010



Unlocked



Locked

Patent No. 1718821

FINGER GUARDS / SPECIALITY SEALS

## SYSTEM SPECIFICATIONS

### Test evidence

- ▶ Maintains acoustic performance of drop seal 41dB (BS EN ISO 10140-1: 2010+A2: 2014, Annex J).
- ▶ Fire: BS 476-20/22: 1987 in an FD30.\*
- ▶ Fire: BS 476-20/22: 1987 in an FD60.\*
- ▶ Smoke: BS EN 1634-3:2004 at ambient and medium temperature; effective smoke seal up to 200°C.
- ▶ Classified to BS EN 12051: 2000.
- ▶ Durability: 50,000 cycles.

### Performance

- ▶ Protects against sound, smoke, fire, draught, light + insects (LAS8001 si).
- ▶ LAS9010 is a security device. Its unique wrap-around shape of bolt enhances security.
- ▶ Flush bolt integrates seamlessly with the drop seal; no extra kits required.
- ▶ Smooth locking action with branded levers.
- ▶ Does not penetrate the drop seal gasket.

### Min/max gap size

- ▶ 1mm/13mm.

### Location

- ▶ Double swing doors.
- ▶ For use on both right + left handed doors.
- ▶ Suitable for bottom + top of the door.

### Material

- ▶ Flush bolt - brushed stainless steel.
- ▶ Seal material - grey or black silicone rubber.

### Drop seal standard lengths

- ▶ 335mm, 435mm, 535mm, 635mm, 735mm, 835mm, 935mm, 1035mm, 1135mm + 1235mm.
- ▶ Note: each length can be cut to the next size down. The 335mm can be cut back to 255mm.

### Fixing

- ▶ LAS9010 is semi-mortised onto the top + bottom of the door.
- ▶ Fixing screws are supplied.
- ▶ Flush bolt is positioned into the keep.
- ▶ Drop seal end plate is not required.
- ▶ No extra adapter kits required.

### Use with

- ▶ All standard lengths of LAS8001 si, with the ability to cut to size.
- ▶ \*Cladding kits must be used for fire rated variants.

### Classification



# LAS9030

MEDIUM DUTY

A durable safety finger guard seal, which provides a deterrent to fingers becoming jammed on the hinge cavity side of a door. The product is fixed to the door and the jamb on the hinge cavity side. Trapping fingers in hinged doors can cause horrendous injuries. The risk is especially high in locations where young children are present. To be used in conjunction with LAS9050 si finger guard seal for the hinge knuckle side.



FINGER GUARDS / SPECIALITY SEALS



▲ LAS9030  
(shown with LAS9050 si)

## SYSTEM SPECIFICATIONS

### Test evidence

- ▶ Tested to BS 8613:2017 (Finger protection devices for pedestrian doors - Type A, Class 2).
- ▶ Durability: 300,000 cycles.

### Performance

- ▶ Protects against draught and light.

### Location

- ▶ Jamb of hinged doors. It can be used on doors with an opening of 170° when used with LAS9050 si. 180° can be obtained when LAS9030 is used on its own.

### Use with

- ▶ LAS7001 si perimeter seal and LAS8001 si drop seal (fully mortised).

### Seal material

- ▶ Black EPDM rubber.

### Standard lengths

- ▶ 2.1m. Other lengths to special order.

### Fixing

- ▶ Self-tapping wood screws are supplied (self-drilling and self-tapping screws for metal construction available on request)
- ▶ Fixing holes are pre-drilled and slotted to allow the seals to be adjusted and positioned accurately. PVC cover strips to conceal fixings are supplied.

### Finishes

- ▶ Silver anodised aluminium with grey cover strip and black gasket as standard.
- ▶ Bronze anodised aluminium with black cover strip and black gasket are subject to non-standard charges and additional lead times.

### Specification

# LAS9050 si & LAS9070 si

## MEDIUM DUTY

This medium duty finger guard seal system provides a shield to trapping fingers in hinged doors, which can cause horrendous injuries. Protects both sides of the door by using the LAS9050 si on the hinge knuckle side and the LAS9070 si on the hinge cavity side.

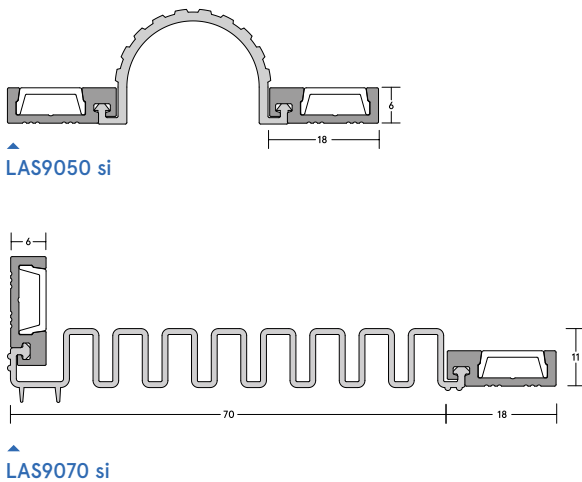

### SYSTEM SPECIFICATIONS

#### Test evidence

- ▶ Tested to BS 8613:2017 (Finger protection devices for pedestrian doors - Type A, Class 1).

#### Performance

- ▶ Protects against draught and light.
- ▶ Suitable for wheeled traffic.

#### Location

- ▶ Jambes of hinged doors. LAS9070 si can be used on doors with an opening of 180°.

#### Use with

- ▶ LAS7001 si perimeter seal and LAS8001 si drop seal (fully mortised).

#### Seal material

- ▶ Silicone.

#### Standard lengths

- ▶ 2.1m. Other lengths to special order. Single doorset packs are available containing 1 x 2.1m LAS9050 si and 1 x 2.1m LAS9070 si.

#### Fixing

- ▶ Self-tapping wood screws are supplied (self-drilling and self-tapping screws for metal construction available on request).
- ▶ Fixing holes are pre-drilled and slotted to allow the seals to be adjusted and positioned accurately. PVC cover strips to conceal fixings are supplied.

#### Finishes

- ▶ Silver anodised aluminium with grey cover strip and black gasket as standard.
- ▶ Bronze anodised aluminium with black cover strip and black gasket are subject to non-standard charges and additional lead times.
- ▶ Black or brown gaskets are available to special order (non-standard - charges and lead times apply).

#### Specification



# FINISHES INFORMATION

**Our wide range of colours and finishes provides inspiration for all types of buildings; from luxurious and contemporary hotels, to bright and bold nurseries and schools – there's a perfect colour or finish available to suit every project.**

An in-house, RAL colour matching service is also available for those wishing to coordinate seals with other architectural features, such as door furniture and trims. Special colours are created using a powder coated finish for a higher aesthetic or to complement bespoke interiors. All architectural seals are manufactured in Lorient's UK facility, to exacting standards and have been designed and developed to deliver the perfect combination of stylish looks and outstanding performance.

We extend our offering way beyond colour and finishes – specialising in assisting and developing customised solutions through collaboration with our customers. Utilising in-house expertise, custom-made products are created to suit customers' requirements.

Special order: additional charges, minimum order quantities and extended lead times apply. Contact our customer services team for availability.



**Call our Customer Services team**

**+44 (0) 1626 834252**

**[www.lorientuk.com](http://www.lorientuk.com)**





# TESTING + TECHNICAL SERVICES

We've built our reputation on the quality and dependability of our products, and our investment in R&D has played a pivotal role in keeping our products at the forefront of our industry. Our dedicated Testing and Technical Services division has established itself as an important facility for manufacturers and designers of doors, windows, glazing systems and hardware, to name just a few.

## TESTING SERVICES

Whether you're investigating new materials, or developing new or existing products, right through to durability testing and benchmarking performance – our team of experts will support you throughout the process. We are able to offer:

- ▶ Fire testing (indicative)
- ▶ Smoke leakage
- ▶ Air leakage
- ▶ ATG commissioning and maintenance for fire & smoke resisting air transfer grilles
- ▶ Mechanical cycling
- ▶ Environmental chamber analysis
- ▶ Attendance at external fire tests
- ▶ Consultancy services.

▶  
Lorient Indicative Furnace

# ADDITIONAL INFORMATION

## TECHNICAL REFERENCES

Lorient is quality assured under the disciplines of BS EN ISO 9001:2015.

Accreditation to this standard is an assurance that we conduct our business to the complete satisfaction of our customers with regard to design solutions, manufacturing consistency and management procedures.

As a result, this internationally recognised standard for quality management generates customer confidence. Regular audits of our company procedures are undertaken by qualified BSI staff to ensure ongoing compliance with all aspects of the standard.

Lorient has attained the BS EN ISO 14001:2015 accreditation for environmental management. This internationally recognised standard shows that we have demonstrated our commitment to responsible environmental behaviour, including prevention of pollution, control and reduction of waste, and ongoing monitoring and improvement of our environmental performance. Achieving ISO 14001 is just one part of our ongoing commitment to operate in a sustainable way.

## FITTING INSTRUCTIONS

Comprehensive fitting instructions are available to download from our website [www.lorientuk.com](http://www.lorientuk.com)

## MAINTENANCE

Periodic inspection/cleaning is recommended for all types of seals. The appearance and performance of brush seals will benefit from a wipe with a damp cloth at least once a year. Worn or damaged seals should be replaced without delay.

## COMPATIBILITY

All Lorient Architectural Seals are compatible with the materials normally used in doors and door frames, including wood, steel, PVC, aluminium and glass.

Please Note: Recommendations as to methods, use of materials and construction details are based on the experience and knowledge of Lorient and are given in good faith as a general guide and a service to designers, contractors and manufacturers.

## GUARANTEE OF ORIGIN

Each production batch of Lorient seals is laser engraved unobtrusively on the edge of the profile with the Lorient name and a code reference. This ensures the product and details of its production can be traced should the need arise.

**Unidentifiable substitute products should never be accepted.**

## MADE IN BRITAIN

We are proud to have been granted the prestigious Made in Britain marque for our products, designed and manufactured at our main facility in South West of the UK.



## INTELLECTUAL PROPERTY

© 2024 Lorient – this brochure is protected by copyright and neither the drawings nor the text may be reproduced or transmitted in any form without prior consent from Lorient. Lorient products described in this brochure are protected by patents and design registrations in Great Britain and other countries.

We are committed to continually enhancing and improving our product range. We reserve the right to change product specifications from time to time without prior notice. E&OE.

June 2024.

## TRADE ASSOCIATIONS

Lorient is a member and active contributor to the following:



## ACCREDITATIONS

### BBA

BBA approvals provide independent assurance for the designer, specifier and end-user as to the 'fitness for purpose' of building products.

### CERTIFIRE

Operated by Exova Warringtonfire, CERTIFIRE is an accredited independent product conformity scheme that requires products to meet the requirements of the tests, to add minimal resistance to opening and closing forces, to prove long term performance under a variety of service conditions, and to be permanently marked for easy identification.

### IFC

IFC Certification Ltd is a UKAS approved and internationally recognised provider of third party Certification services – designed to give confidence to specifiers, users, occupiers, owners and enforcement bodies that products have been thoroughly and independently evaluated and will continue to be manufactured to the same specification as originally tested.

### UL

UL is a global independent safety science company that tests a diverse range of products; representative samples of a product must be tested and meet UL's stringent requirements to carry the marque. These requirements are based primarily on UL's published and nationally recognised Standards for Safety. Businesses, consumers and regulatory authorities around the world recognise the trusted rigour and technical excellence of UL certifications. Lorient is proud to have achieved the UL Mark on many of its products. These are detailed on individual pages.

# CPDs

We offer three fully-accredited CPD seminars. Impartially presented by knowledgeable speakers, the seminars are structured to be technically informative, and provide practical advice.

## Performance Door Design: The Basics of Sound Reduction

Effective acoustic containment helps to improve the quality of the built environment, preserving privacy as well as excluding unwanted noise. With changing regulations, it's essential to be informed of the relevant requirements and the implications for door assemblies.

### Our acoustic CPD seminar covers:

- ▶ the nature of sound, examining airborne transmission of sound;
- ▶ regulatory requirements and British Standards that relate to acoustic performance;
- ▶ test procedures and interpretation of test reports;
- ▶ effective design of door assemblies for acoustic performance, including door construction and the influence of sealing systems;
- ▶ design conflicts between acoustic performance, durability and ease of operation of the door;
- ▶ independent accreditation.

## The Role and Performance of Fire and Smoke-Resisting Door Assemblies

The importance of fire and smoke resisting door assemblies is illustrated by the 216 fire related fatalities and 5,545 casualties in fires (England 2022/23). Apart from the human toll, property losses each year approach £2.52 billion.

### Our fire and smoke containment CPD seminar covers:

- ▶ hard facts concerning deaths, injuries and property damage caused by fire and smoke;
- ▶ regulatory requirements for fire and smoke resisting door assemblies;
- ▶ the nature and behaviour of smoke;
- ▶ effective design of door assemblies for smoke containment, including the threshold gap;
- ▶ design conflicts between fire containment, smoke containment, durability and ease of operation of the door;
- ▶ independent accreditation.

## The Regulatory Reform (Fire Safety) Order 2005 and its implications for fire doors

The RRO consolidated 70 pieces of legislation; shifted responsibility for fire safety management; abolished the Fire Safety Certificate; established the Fire Risk Assessment and created major change in legal liability.

### Our RRO CPD seminar covers:

- ▶ an overview of the RRO;
- ▶ product solutions;
- ▶ the dangers of fire and smoke;
- ▶ the importance of fire doors – including installation and maintenance.

Our CPD materials have been independently verified and certified by the RIBA as CPD approved. A certificate for 1 hour's CPD will be provided, which contributes to Continuing Professional Development requirements.

If you are interested in booking a seminar, please contact our Marketing department or email [cpd@lorientuk.com](mailto:cpd@lorientuk.com)



# AIR TRANSFER GRILLE CPD WEBINAR

We're delighted to offer a CPD entitled:  
The Specification + Design of Air Transfer Grilles / Dampers.

This is a fantastic addition to our growing collection of CPD seminars and explores:

- ▶ the latest test standards and building regulations;
- ▶ the major difference between intumescent air transfer grilles and dampers;
- ▶ the importance of correct specification, installation and maintenance;
- ▶ plus it offers practical solutions to fire and smoke containment over a range of applications.

All of our CPD seminars are available to view virtually, please visit [www.lorientuk.com](http://www.lorientuk.com) or email [cpd@lorientuk.com](mailto:cpd@lorientuk.com) for more information.



# COMPREHENSIVE SUPPORT

We continue to lead the way in Research + Development. As a company we have over 40 years' experience, so our experts are well equipped to listen, help and advise you on your sealing system requirements.

## Technical Services

We're happy to provide specialist advice on acoustic, smoke and fire protection for refurbishment and new build projects. If you need assistance, you can call our Technical Services team.

Alternatively, we can arrange a site visit to get a clearer idea of your needs and how we can help you. We also provide copies of test reports and samples where needed; and can give guidance on how best to meet Building Regulations and Standards.

## Web Support

Our website features a comprehensive range of supporting documents covering the entire range of products, including installation guides and CAD drawings. All of our brochures and products sheets are also available for download, together with copies of certification and specification texts.

## Online Acoustic Search tool

Our Acoustic Search tool on our website gives you quick and easy access to a wide range of tested acoustic sealing systems on a variety of popular door constructions & configurations.

[www.lorientuk.com/acousticsearch](http://www.lorientuk.com/acousticsearch)

The tool allows users to select a specific decibel rating; along with door configuration, fire door rating, doorset type etc to filter the results. The 'Acoustic Search' tool is updated frequently with Lorient's ever-expanding portfolio of test evidence. If you're looking for high performance or specialist applications – please contact us on **+44 (0) 1626 834252**, there may be some additional configurations we haven't yet published.

## Customisation

If you have a particular requirement which isn't covered by the applications in this brochure, we may be able to supply an existing non-standard item, or even develop a customised solution for you. Utilising in-house expertise, bespoke products are created to your requirements; from a functional or aesthetic perspective, or both.

Lorient's dedicated Technical Services team supports and works as part of your design team, offering informed product advice and guidance on regulatory requirements and standards.



**Call our Technical Services team**

**+44 (0) 1626 834252**

**[www.lorientuk.com](http://www.lorientuk.com)**

---

# SEALING SOLUTIONS

Detailed information about our products can be found in the following brochures:

## Lorient Architectural Seals

A variety of door sealing systems including perimeter seals, drop seals, threshold plates, door bottom seals and many more.

## Fire, Smoke and Acoustic Seals for Door Assemblies

Our core range of high performance fire, smoke and acoustic seals.

## Fire and Smoke Resistant Air Transfer Grilles

A comprehensive range of fire, and fire and smoke resistant intumescent air transfer grilles for doors, walls, ducts, floors and ceilings.

## Fire Resistant Door Hardware Protection

Letterplates, door edge protectors and intumescent kits that can safely be installed into fire rated doors without compromising the fire/smoke performance.

## Fire Resistant Glazing Systems

Fire resistant glazing systems for doors, screens and partitions

## Acoustic Sealing Systems for Door Assemblies

A comprehensive series of acoustic sealing systems for various types of door construction.

Copies of these brochures are available by calling **+44 (0)1626 834252** or download from our website **[www.lorientuk.com](http://www.lorientuk.com)**





**UK / EUROPE**

T: +44 (0) 1626 834252  
E: sales@lorientuk.com

**AUSTRALIA**

T: +61 (0) 3 8574 3888  
E: customerservice.au@assaabloy.com

**SINGAPORE**

T: +65 6880 0000  
E: sales.lorient@assaabloy.com

**HONG KONG**

T: +852 2260 0888  
E: sales@lorienthk.com

**UAE**

T: +971 4 8804888  
E: mktg@lorientuk.com

**USA**

T: +1 859 252 7441  
E: info@lorientna.com

For further information about  
Lorient products please visit:  
[www.lorientgroup.com](http://www.lorientgroup.com)



@lorientuk



/company/lorient



@lorientuk



@lorientuk



@lorientuk



@lorientuk